

FEATURES:



Models Single output

- AC-DC Constant Current or Constant Voltage LED Driver
- Input range 90-305VAC/47-440Hz
- High efficiency up to 84%
- Operating temperature -40 to 85°C
- Dimmable via resistive / 0-10Vdc / PWM
- 5 Years Limited Warranty

- Over temperature protection
- Over current protection
- Waterproof case rated IP68
- Power Factor Correction
- Short circuit protection



Submersible



RoHS



Model	Max Output Power (W) ^①	Output Voltage Range (V) ^③	Output Current (A) ^③	Input Voltage (VAC/Hz)	Input Voltage (VDC)	Mode of Operation	Efficiency (%)		
							115 VAC	230 VAC	277 VAC
AMEPR30-5070AZ	35	36-50	0.7	90-305/47-440	130-430	Constant Current	84	83	83
						Constant Voltage ^②	84	83	83
AMEPR30-4864AZ	30.7	36-48	0.64	90-305/47-440	130-430	Constant Current	84	83	83
						Constant Voltage ^②	84	83	83
AMEPR30-36100AZ	36	24-36	1	90-305/47-440	130-430	Constant Current	84	83	83
						Constant Voltage ^②	84	83	83
AMEPR30-24140AZ	33.6	12-24	1.4	90-305/47-440	130-430	Constant Current	83	82	82
						Constant Voltage ^②	83	82	82
AMEPR30-12250AZ	30	5-12	2.5	90-305/47-440	130-430	Constant Current	81	80	80
						Constant Voltage ^②	81	80	80

① Exceeding the maximum output power will permanently damage the converter.

② The dimming feature is not supported when units are used in Constant Voltage mode only.

③ In constant current mode output current is maximum shown, in constant voltage mode output voltage is the maximum shown. All models can be ordered with optional North American colour input wires (black (L), white (N), green (GND)). Add “-NA” to part number when ordering.

NOTE: Aimtec limited warranty of 5 years is valid based on product operation at datasheet specifications at ambient temperature of 25°C, humidity < 75%, nominal input voltage (115/230/277VAC) and at rated output load unless otherwise specified. See <http://www.aimtec.com/terms-sale> AMEPR30-AZ's AC/DC LED drivers have electrical safeguards designed within to protect it from conventional electrical abnormalities with the levels listed in the safety table. Applications for use within rural agricultural, heavy industrial, and other areas or regions which are prone to 'dirty' electrical conditions which would subject any of the above models to excessive voltages surges or spikes, may damage or cause early life failure of product. In this case consideration should be made by the end user to ensure that adequate line or mains surge suppression is installed in front of Aimtec device to ensure the longevity of the products. Failure to identify excessive line surges violations prior to installation may damage sensitive equipment permanently.

Input Specifications

Parameters	Conditions	Typical	Maximum	Units
Current (full load)	115 VAC		430	mA
	230 VAC		250	mA
	277 VAC		210	mA
Inrush current <2ms (cold start)	115 VAC		25	A
	230 VAC		40	A
	277 VAC		55	A
Leakage current	I/O		0.25	mA
	I/FG, O/FG		3.5	mA
Power factor	115 VAC	0.96		
	230 VAC	0.90		
	277 VAC	0.85		
External fuse	Recommended slow blow type	1		A
Start-up time		450		ms

Output Specifications

Parameters	Conditions	Typical	Maximum	Units
Current accuracy		±3		%
Line regulation	(LL-HL)	±2		%
Load regulation	0-100% load	±3		%
Ripple & Noise*		100		mV p-p
Hold-up time		50		ms
Current adjustment range ^⑤		100-10		%

④ Tested with 0.1µF (C/C) or (M/C) and 47µF (E/C) parallel capacitors at the end.

⑤ Note: from 0% to 10% dimming adjustment signal instability may be present.

Isolation Specifications

Parameters	Conditions	Typical	Rated	Units
Tested voltage	I/O		3750	VAC
	I/FG		2000	VAC
	O/FG		500	VAC
Isolation resistance	500VDC	>1000		MΩ

General Specifications

Parameters	Conditions	Typical	Maximum	Units
Switching frequency		130		KHz
Over current protection	AMEPR30-5070AZ		0.77	A
	AMEPR30-4864AZ		0.68	
	AMEPR30-36100AZ		1.04	
	AMEPR30-24140AZ		1.45	
	AMEPR30-12250AZ		2.55	
Over voltage protection	Refer to Constant Current vs. Constant Voltage Mode curve			
Short circuit protection	Auto recovery			
Over temperature protection		110~120		°C
Operating temperature	With derating over 55°C	Refer to model application		°C
Maximum case temperature			100	°C
Storage temperature		-40 to +95		°C
Temperature coefficient		±0.02		% / °C
Cooling	Free air convection			
Humidity	Non condensing		20~95	% RH
Case material	Plastic			
Potting	Epoxy (IP68 rated)			
Wires	UL1015 18AWG * 20CM			
Weight		530		g
Dimensions (L X W X H)	5.30 x 2.27 x 1.59 inches	134.80 x 57.68 x 40.50 mm		
MTBF	>400,000 hrs (MIL-HDBK-217F at t=+25°C)			

Safety Specifications

Parameters		
Agency approvals	cULus, CE	
Standards	UL8750, UL60950-1, EN55022, class B, EN60529(IP68), EN61347-1, EN61347-2-13	
	Information Technology Equipment	EN55022 Class B
	Harmonic Current Emissions	IEC/EN 61000-3-2, Class C
	Voltage fluctuations and flicker	IEC/EN 61000-3-3, (EN60555-3)
	Electrostatic Discharge Immunity	IEC 61000-4-2 Level 3
	RF, Electromagnetic Field Immunity	IEC 61000-4-3 Level 2
	Electrical Fast Transient / Burst Immunity	IEC 61000-4-4 Level 2
	Surge Immunity	IEC 61000-4-5 Level 3
	RF, Conducted Disturbance Immunity	IEC 61000-4-6 Level 2
	Power frequency Magnetic Field Immunity	IEC 61000-4-8 Level 1
	Voltage dips, Short Interruptions Immunity	IEC 61000-4-11

Dimensions

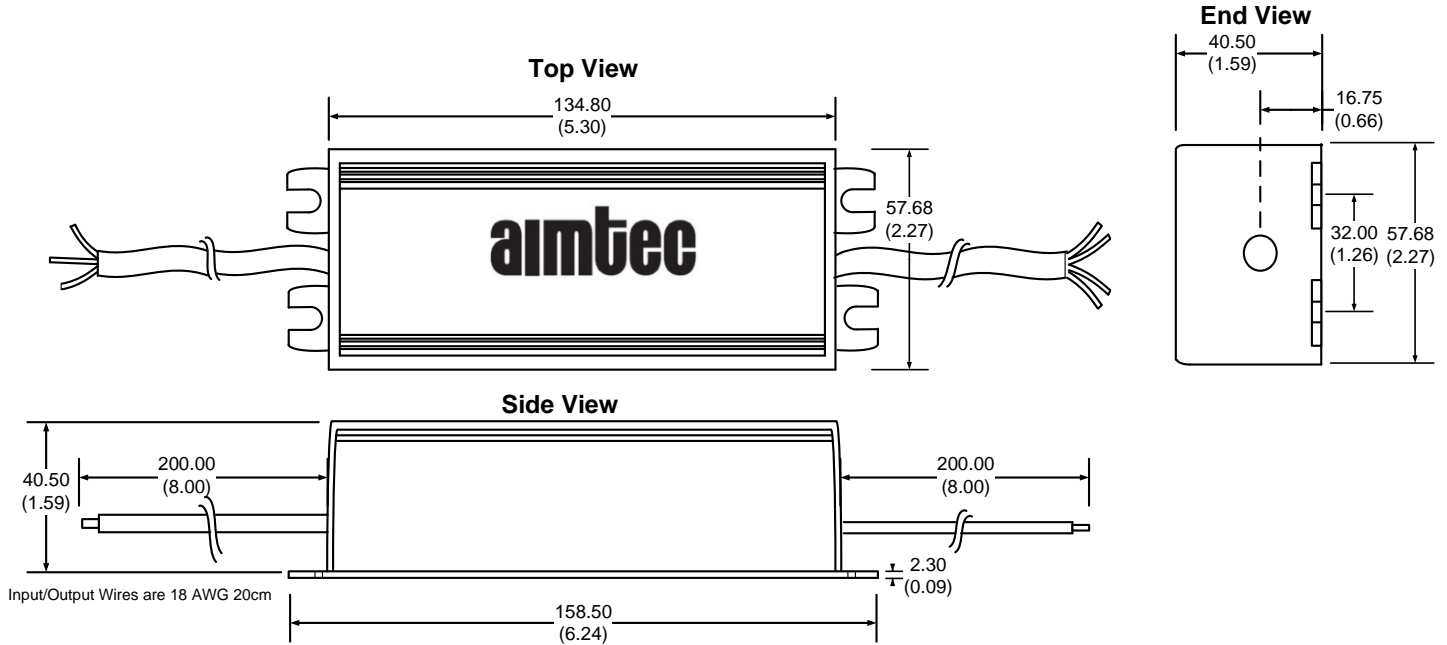

NOTE: to adjust the output current connect a 20K Ohm pot between blue and white wire

Wire connection:

Wire	Connection
Brown	AC L
Blue	AC N
Green	Ground
Red	+V output
Black	-V Output
Blue (Dimming)	+ Vs dimming
White (Dimming)	-Vs dimming

Analog (Resistive) Dimming Application Circuit

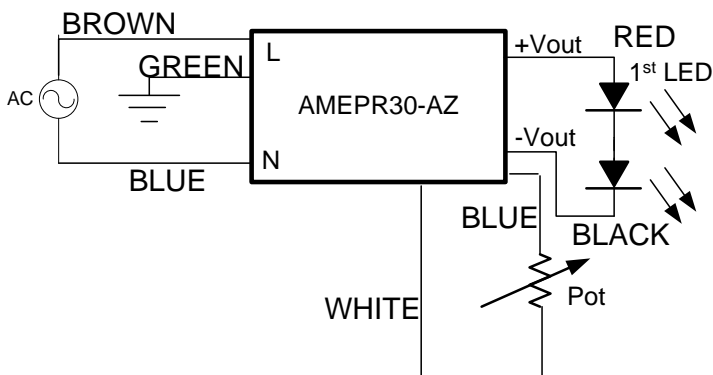

Model Number	Maximum Pot Value (kΩ)
AMEPR30-5070AZ	4.68
AMEPR30-4864AZ	2.98
AMEPR30-36100AZ	11.13
AMEPR30-24140AZ	42.60
AMEPR30-12250AZ	44.04

0-10V Dimming Application Circuit

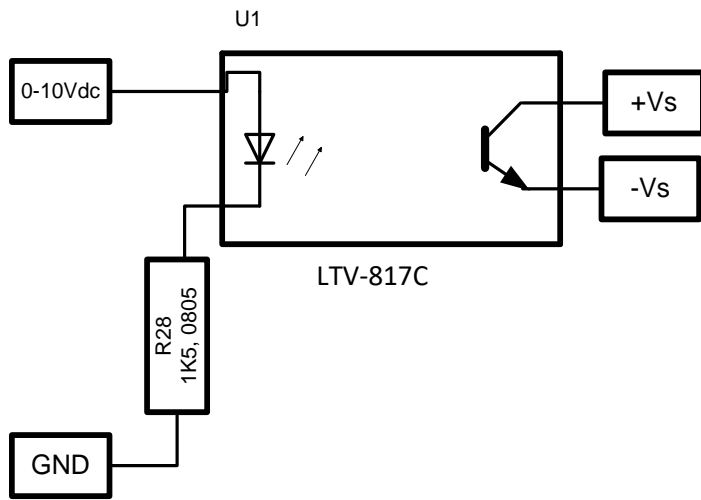

PWM (1KHz) Dimming Application Circuit

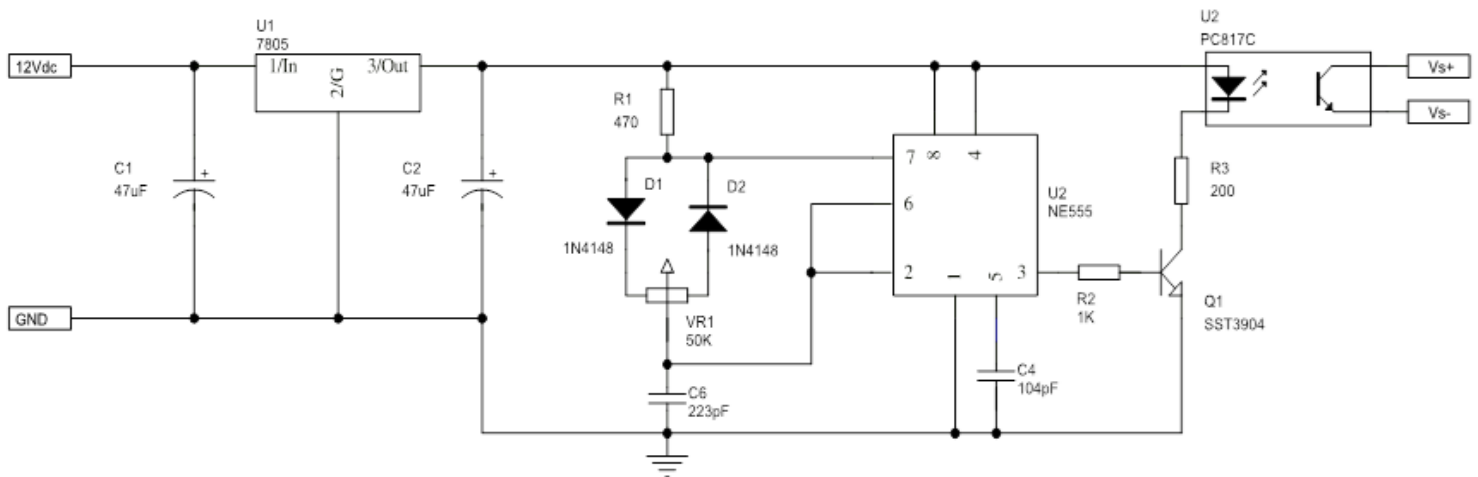

Derating

Free Air Convection

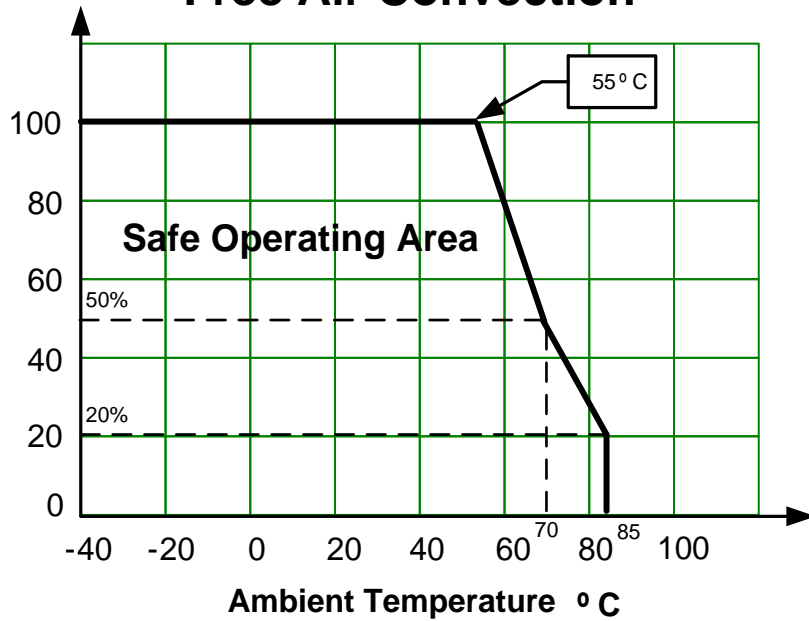

Efficiency Vs. Input Voltage & Output Current (Constant Current Mode)

AMEPR30-5070AZ

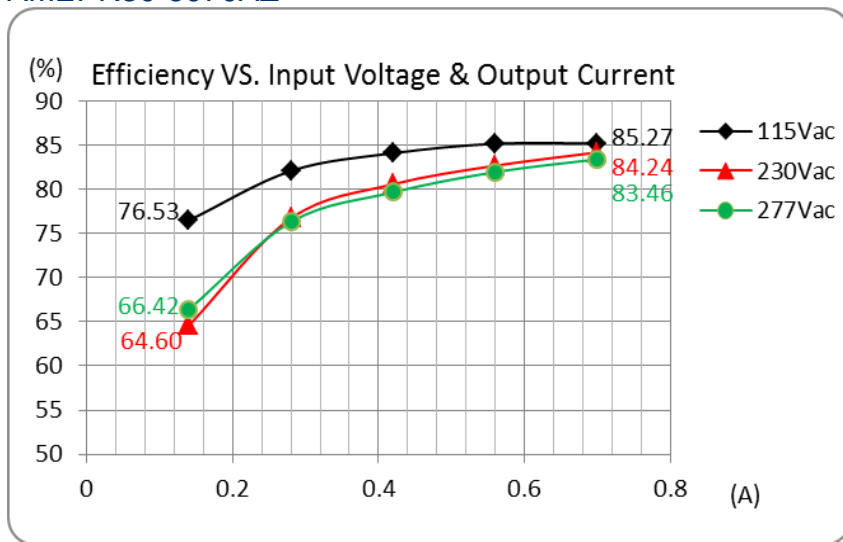

AMEPR30-4864AZ

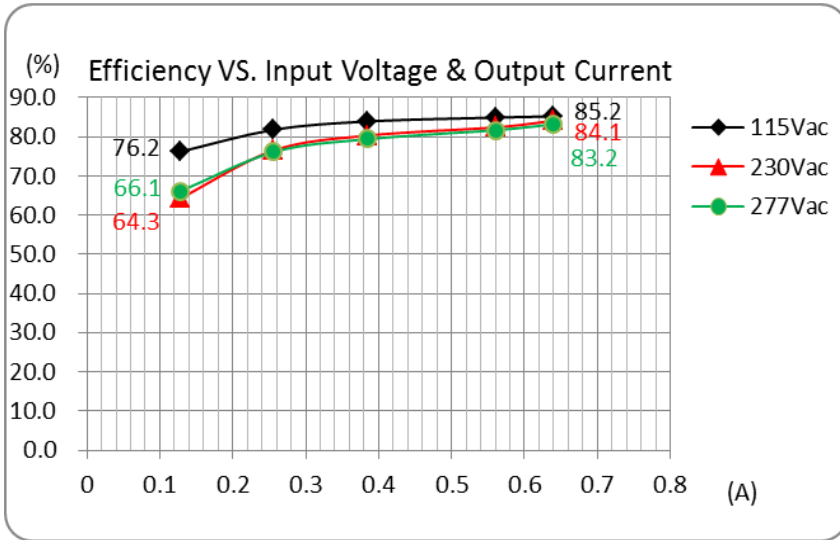

AMEPR30-36100AZ

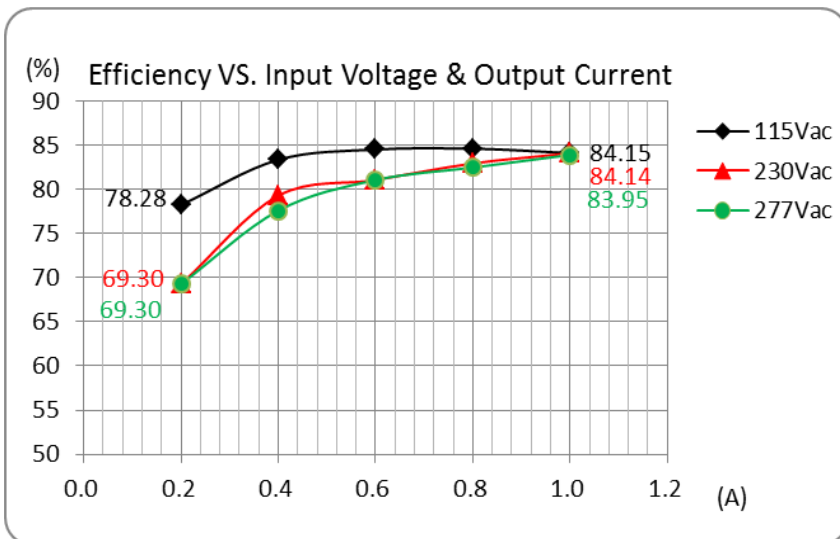

AMEPR30-24140AZ

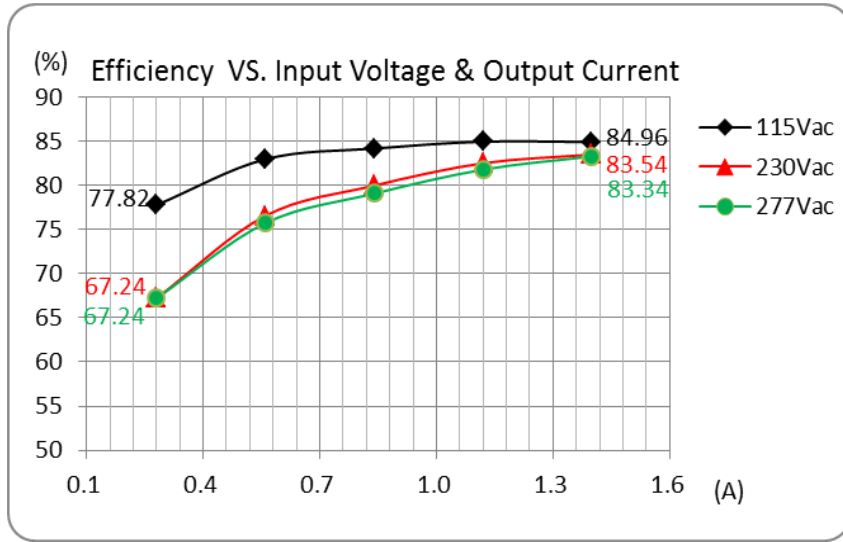

AMEPR30-12250AZ

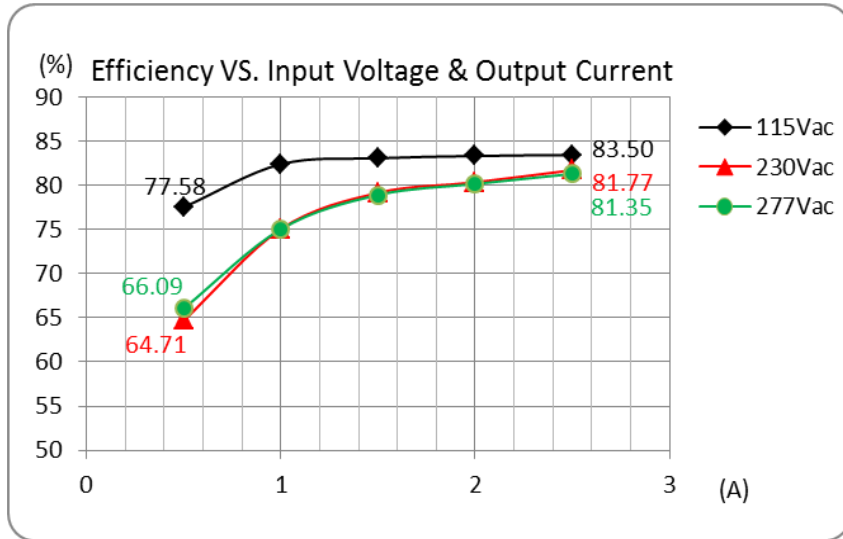

PFC Value vs. Output Load Current (Constant Current Mode)

AMEPR30-5070AZ

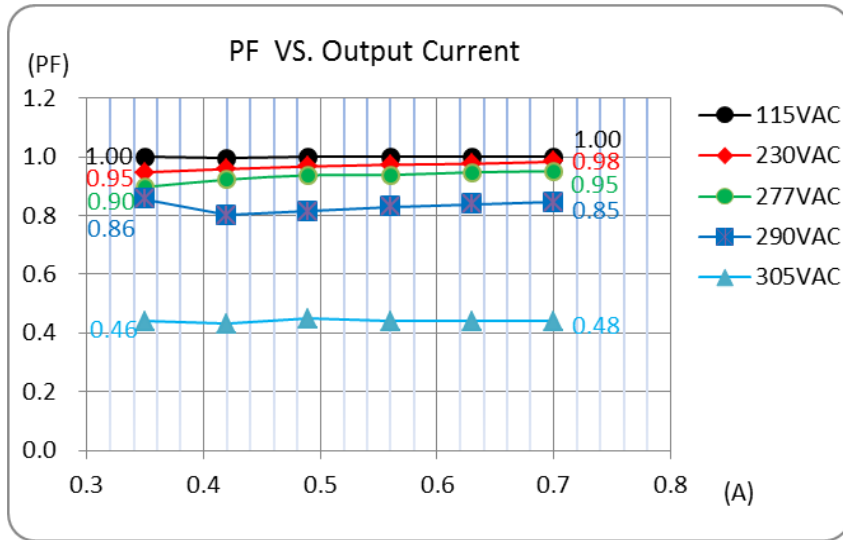

AMEPR30-4864AZ

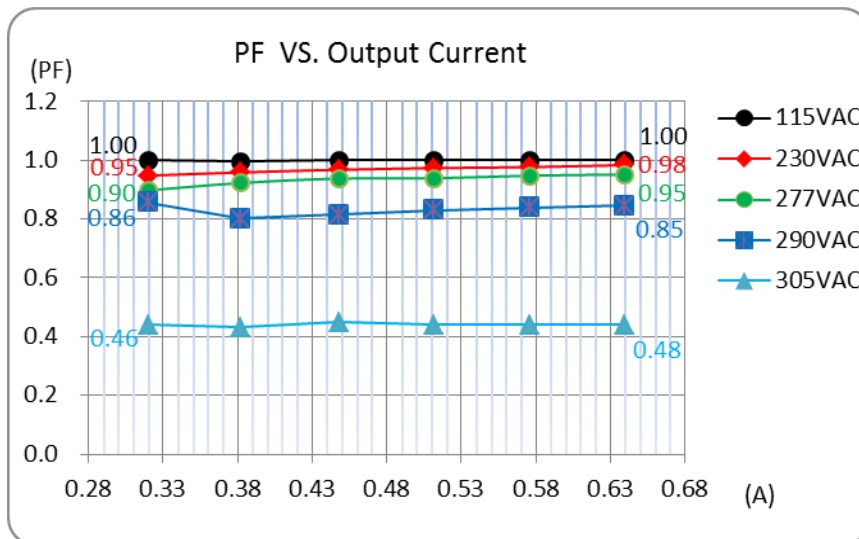

AMEPR30-36100AZ

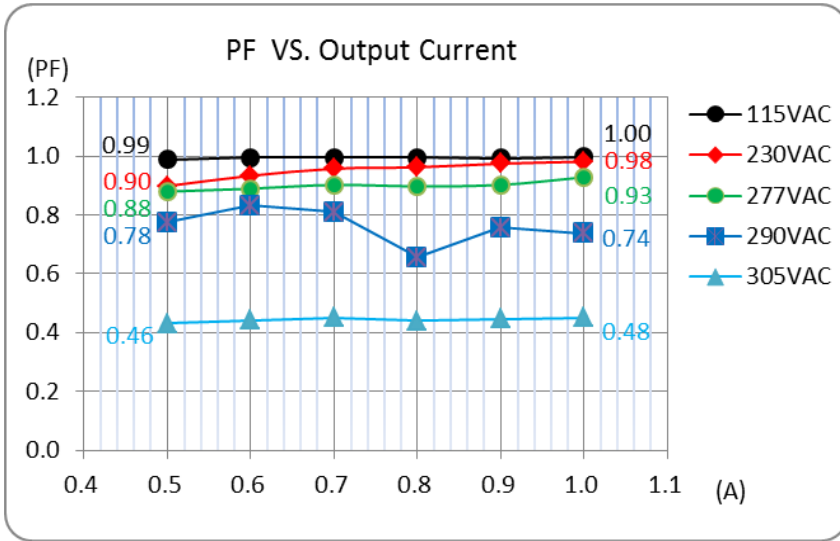

AMEPR30-24140AZ

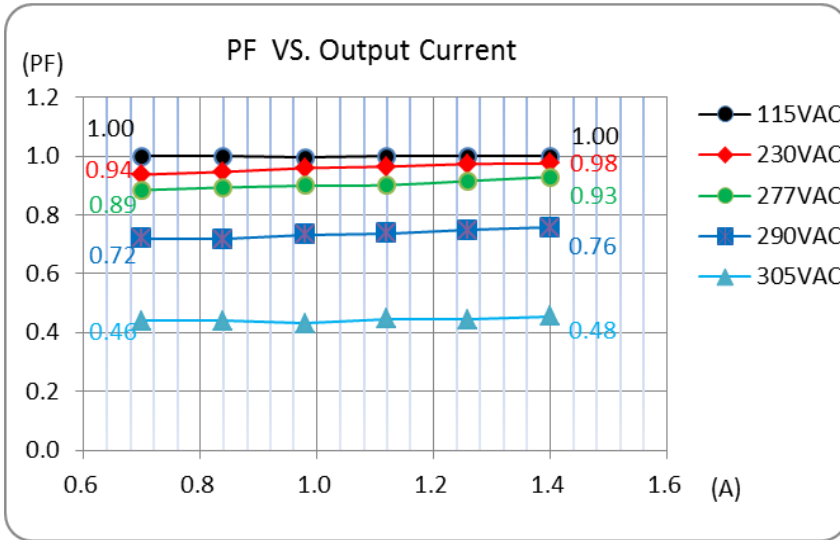

AMEPR30-12250AZ

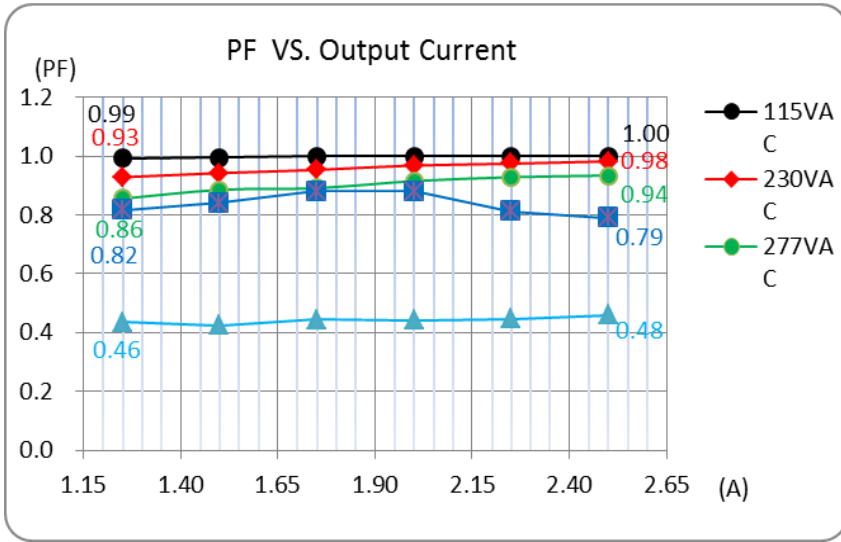

PFC vs. Output power

AMEPR30-5070AZ

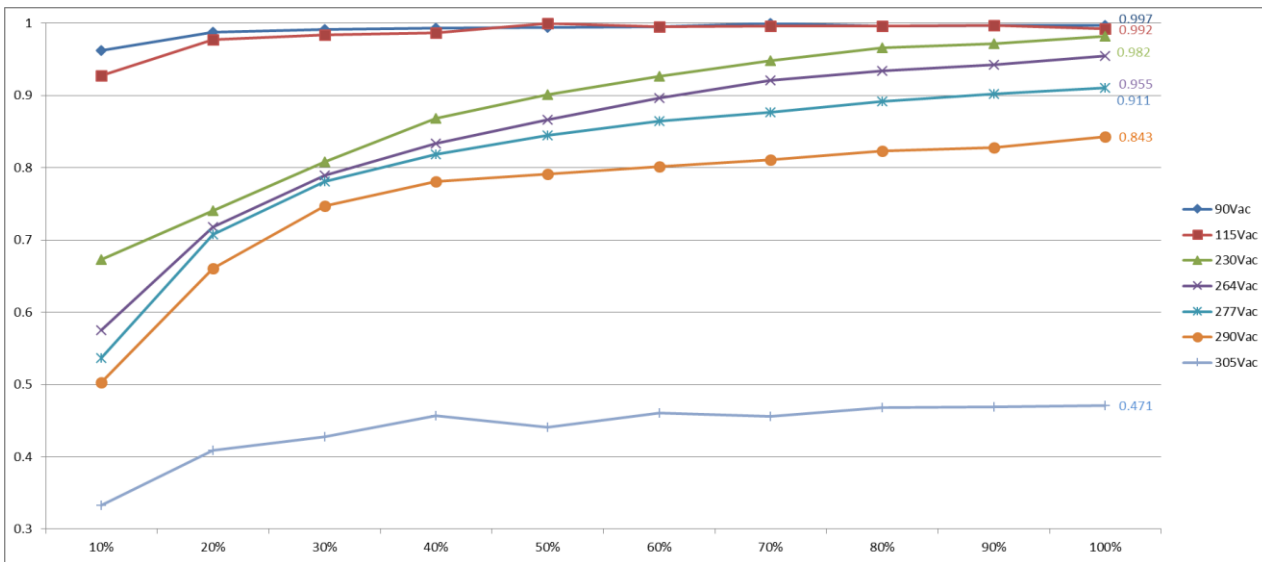

AMEPR30-24140AZ

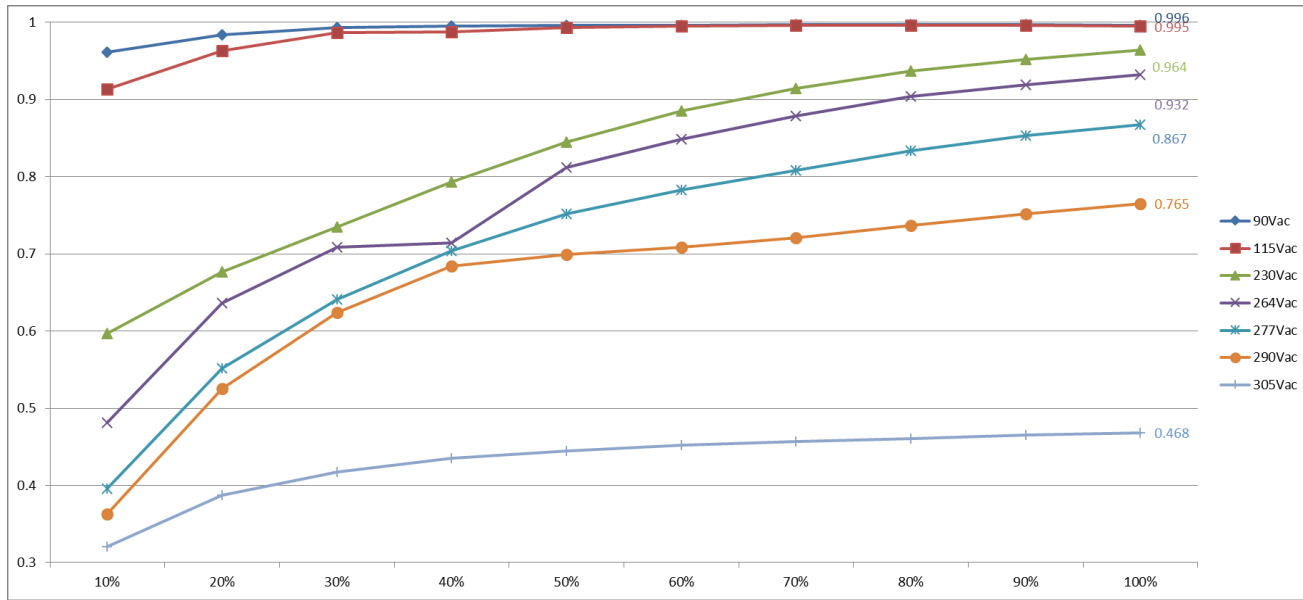

Constant Current vs. Constant Voltage Mode

AMEPR30-5070AZ

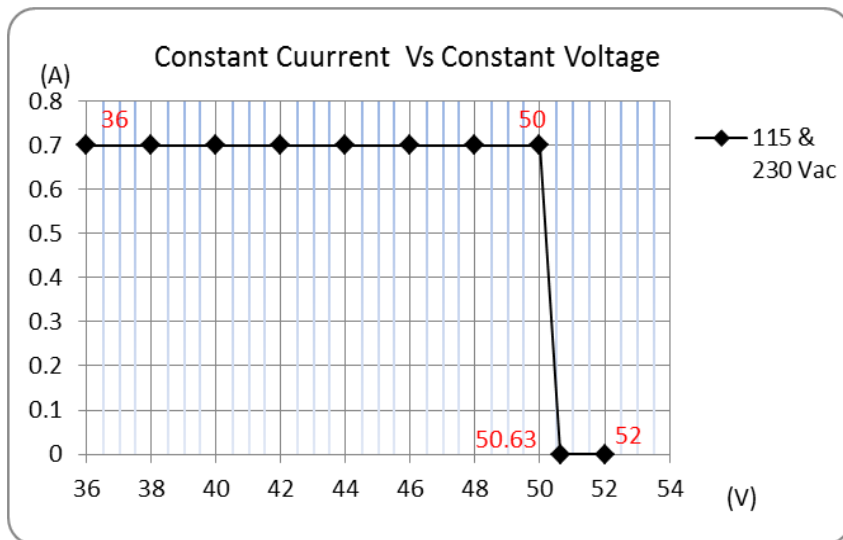

AMEPR30-4864AZ

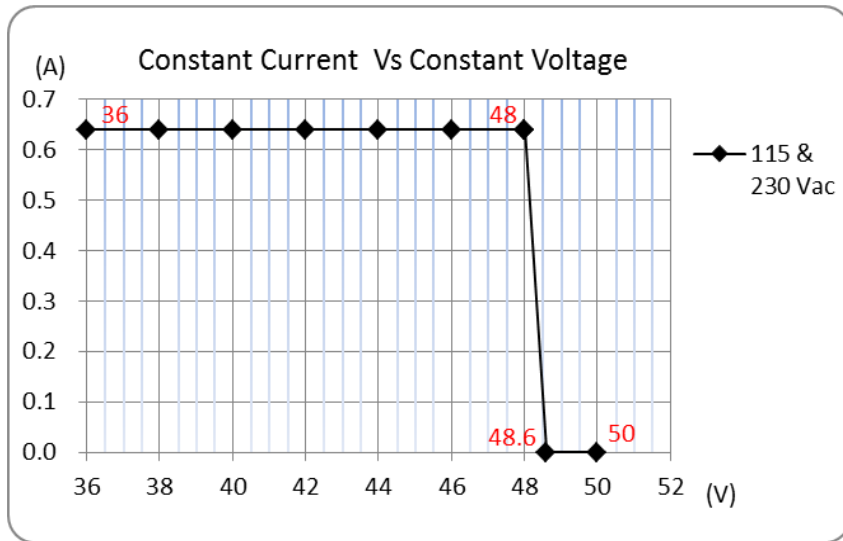

AMEPR30-36100AZ

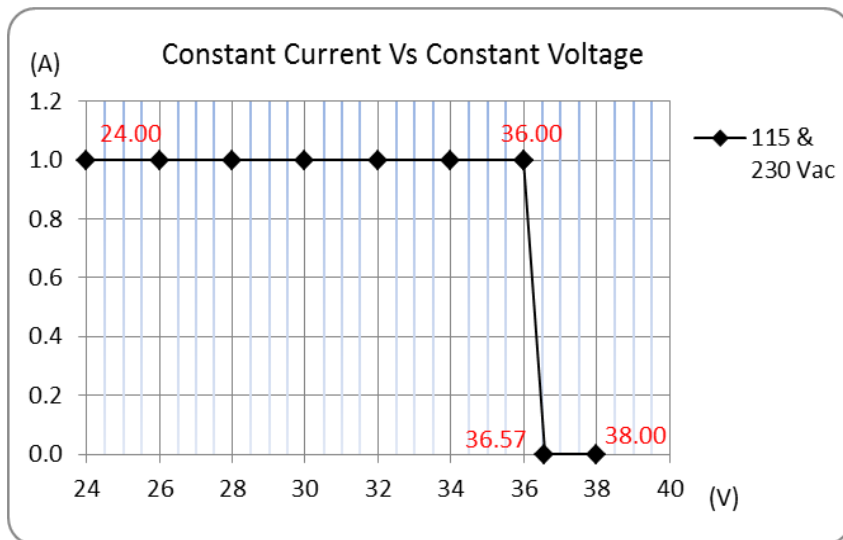

AMEPR30-24140AZ

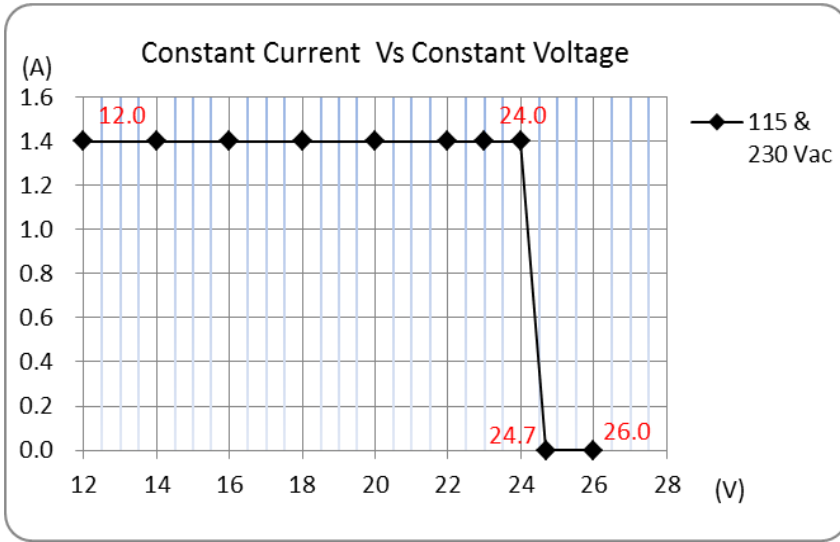

AMEPR30-12250AZ

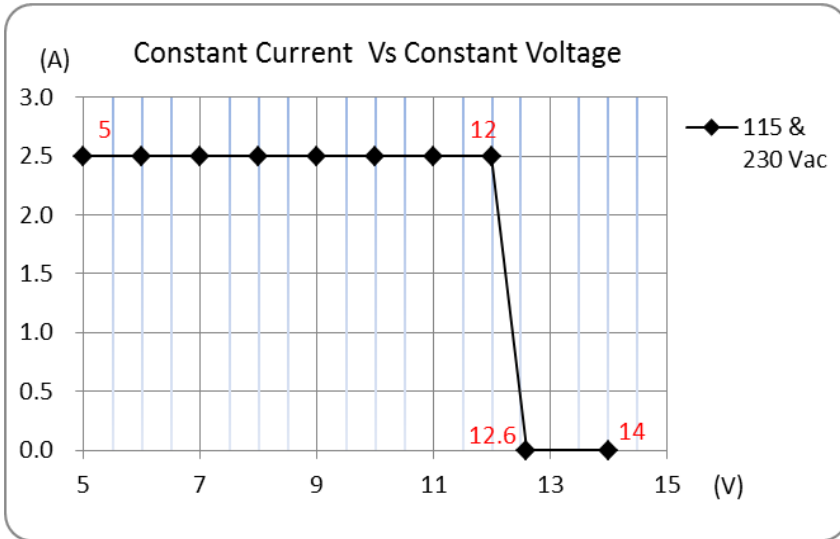

Dimming Control (Output Current vs. Radj)

AMEPR30-5070AZ

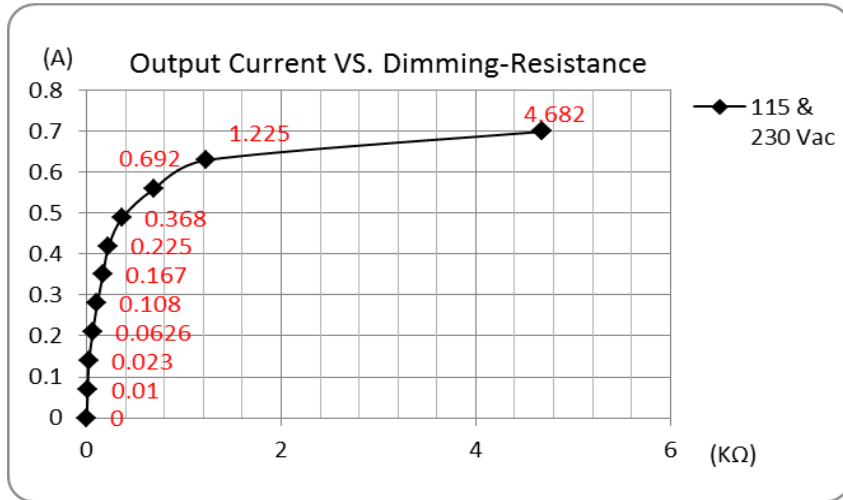

AMEPR30-4864AZ

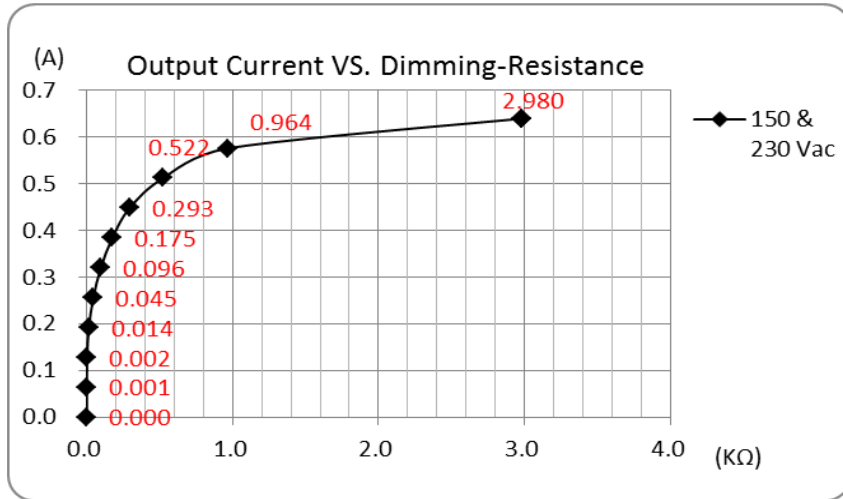

AMEPR30-36100AZ

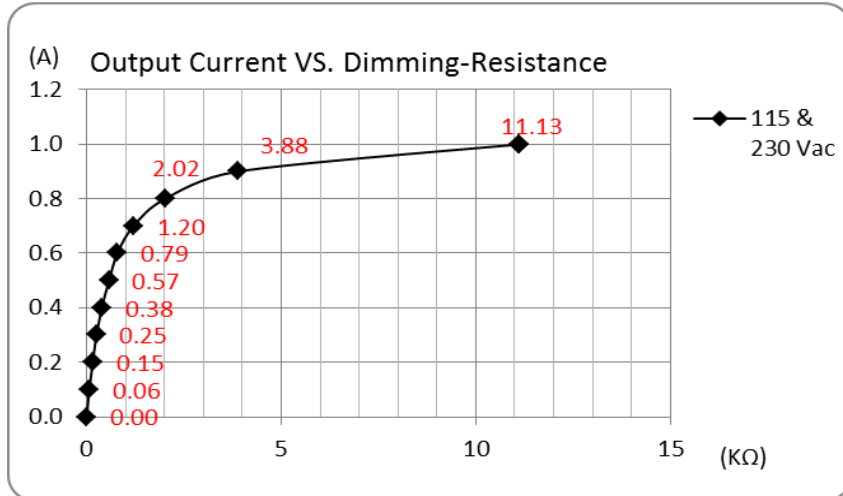

AMEPR30-24140AZ

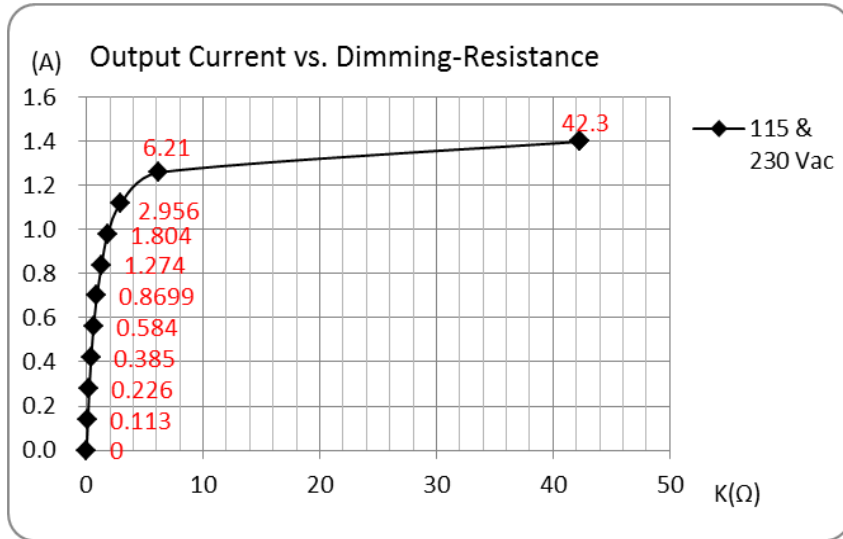

AMEPR30-12250AZ

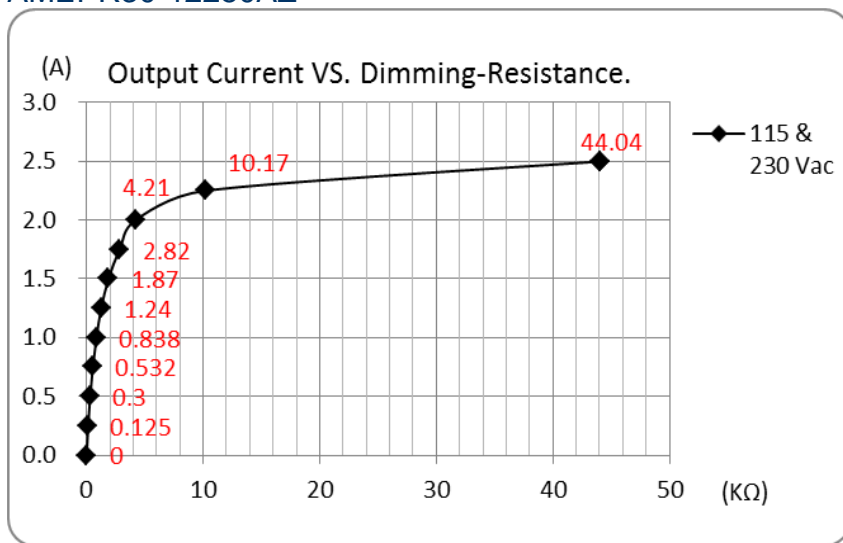

NOTE: 1. Datasheets are updated as needed and as such, specifications are subject to change without notice. Once printed or downloaded, datasheets are no longer controlled by Aimtec; refer to www.aimtec.com for the most current product specifications. 2. Product labels shown, including safety agency certifications on labels, may vary based on the date manufactured. 3. Mechanical drawings and specifications are for reference only. 4. All specifications are measured at an ambient temperature of 25°C, humidity<75%, nominal input voltage and at rated output load unless otherwise specified. 5. Aimtec may not have conducted destructive testing or chemical analysis on all internal components and chemicals at the time of publishing this document. CAS numbers and other limited information are considered proprietary and may not be available for release. 6. This product is not designed for use in critical life support systems, equipment used in hazardous environments, nuclear control systems or other such applications which necessitate specific safety and regulatory standards other the ones listed in this datasheet. 7. Warranty is in accordance with Aimtec's standard Terms of Sale available at www.aimtec.com.