



FEATURES:

- High Power LED Driver
- Wide (7:1) Input Voltage Range
- Remote Control Function
- 24 Pin DIP Package or 2x1 Inch Package Types
- Constant Output Current
- High Efficiency (Up to 96%)
- PWM Digital Dimming Function (10 – 90%)
- Analogue Dimming Function (0 – 100%) ^①



Models

Single output

Model	Input Voltage (Vdc)	Output Voltage (Vdc)	Maximum Rated Current (mA)	Efficiency Max (%)
AMLD-3630IZ	5-36	2-32	300	96
AMLD-3635IZ	5-36	2-32	350	96
AMLD-3650IZ	5-36	2-32	500	96
AMLD-3660IZ	5-36	2-32	600	96
AMLD-3670IZ	5-36	2-32	700	96
AMLD-3680IZ	5-36	2-32	800	96
AMLD-3690IZ	5-36	2-32	900	96
AMLD-36100IZ	5-36	2-32	1000	96
AMLD-36110IZ	5-36	2-32	1100	96
AMLD-36120IZ	5-36	2-32	1200	96
AMLD-36130IZ	5-36	2-32	1300	95
AMLD-36140IZ	5-36	2-32	1400	95
AMLD-36150IZ	5-36	2-32	1500	95
AMLD-36160IZ	5-36	2-32	1600	95
AMLD-36180IZ	5-36	2-32	1800	95
AMLD-36200IZ	5-36	2-32	2000	95

NOTE: All specifications in this datasheet are measured at an ambient temperature of 25°C, humidity < 75%, nominal input voltage and at rated output load unless otherwise specified. ^① Analogue dimming is not supported on 1.6A, 1.8A, 2.0A models

Input Specifications

Parameters	Nominal	Typical	Maximum	Units
Voltage range	24	5-36	36	VDC
On/Off Control (Analog Control)	ON: Open or 0V > V < 0.6V			
Input voltage range (0-12Vdc) (Leave open if not used)	OFF: 0.6V > V < 5V (1mA Max)			
Dimming Control (Digital Control)	Max PWM Frequency (10%~90%) 200Hz / 20KHz for all models			
Dimming Control (Analog Control)	0-4.5V (1mA max) Analog Voltage (0%~100%) models: AMLD-3630IZ, AMLD-3635IZ, AMLD-3650IZ			
Input voltage range (0-12Vdc)* (Leave open if not used) For models with 1.5A and below	0-6.5V (1mA max) Analog Voltage (0%~100%) models: AMLD-3660IZ, AMLD-3670IZ, AMLD-3680IZ, AMLD-3690IZ, AMLD-36100IZ, AMLD-36110IZ, AMLD-36120IZ			

NOTE: Exceeding 12Vdc on Dimming Control pin will damage the converter.

Output Specifications

Parameters	Conditions	Typical	Maximum	Units
Current accuracy		±2		%
Short Circuit protection	Regulated at the rated current for each model			
Output Open Protection	No Load			
Max load capacitance			100	µF
Ripple & Noise	20MHz Bandwidth	300		mV p-p

General Specifications

Parameters	Conditions	Typical	Maximum	Units
Switching frequency	100% load	260	1.5MHz for 1.6A, 1.8A, 2.0A models	KHz
Operating temperature		-40 to +85		°C
		-40 to +70 (1.2A, 1.3A, & 1.5A, 1.6A, 1.8A, 2.0A models)		
Storage temperature		-40 to +125		°C
Max Case temperature			100	°C
Cooling	Free Air Convection			

Thermal Impedance		13.17		°C/W
Humidity			95	% RH
Case material	Non-Conductive Black Plastic, Nickel-Coated Copper 1.3A, 1.4A & 1.5A models)			
Potting material	Epoxy (Flammability UL94V-0)			
Weight		12		g
Dimensions (L x W x H)	1.25 x 0.80 x 0.40 inches / 31.80 x 20.30 x 10.20 mm			
	1.25 x 0.80 x 0.43 inches / 31.80 x 20.30 x 11.00 mm (1.3A, 1.4A, & 1.5A models)			
	1.99 x 0.99 x 0.37 inches / 50.70 x 25.30 x 9.55 mm (1.6A, 1.8A, 2.0A models)			

Safety Specifications

Parameters	
Agency approvals	CE
Standards	EN 55022, class B
	EN55024
	IEC 61000-4-2 (Perf. Criteria B)
	IEC 61000-4-3 (Perf. Criteria A)
	IEC 61000-4-6 (Perf. Criteria A)
	IEC 61000-4-8 (Perf. Criteria A)

Pin Out Specifications

Pin	Single
1	Remote On/Off
2	-Vin
3	-Vin
9	NC
11	NC
14	LED +
16	LED -
22	+Vin
23	+Vin
24	DIM

NC: Not Connected

Dimensions (0.3A to 1.2A models)

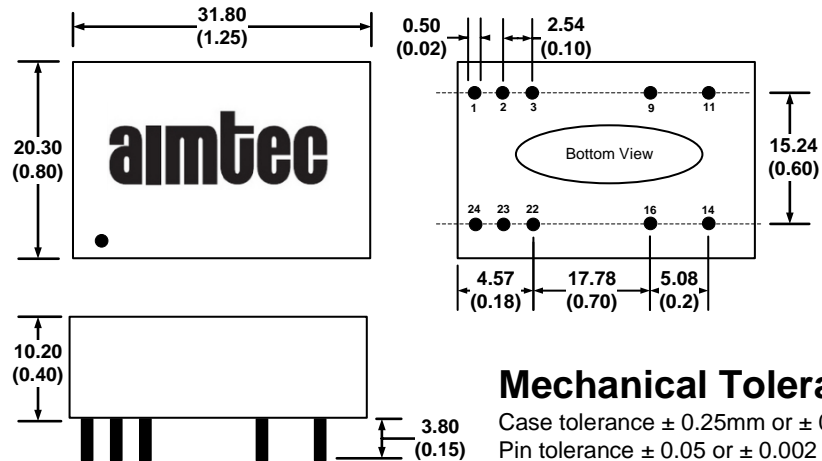

Mechanical Tolerances
Case tolerance $\pm 0.25\text{mm}$ or ± 0.01 inches
Pin tolerance ± 0.05 or ± 0.002

Dimensions (1.3A, 1.4A, & 1.5A models)

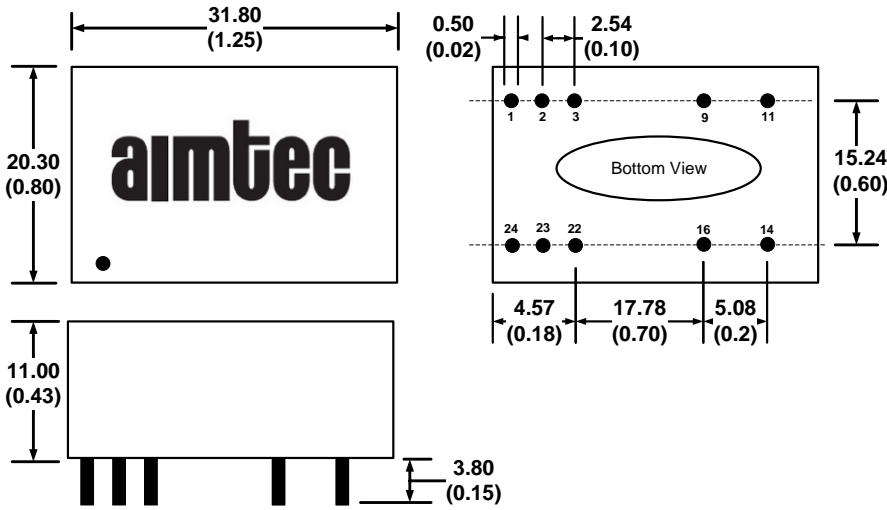

Dimensions (1.6A, 1.8A, & 2.0A models)

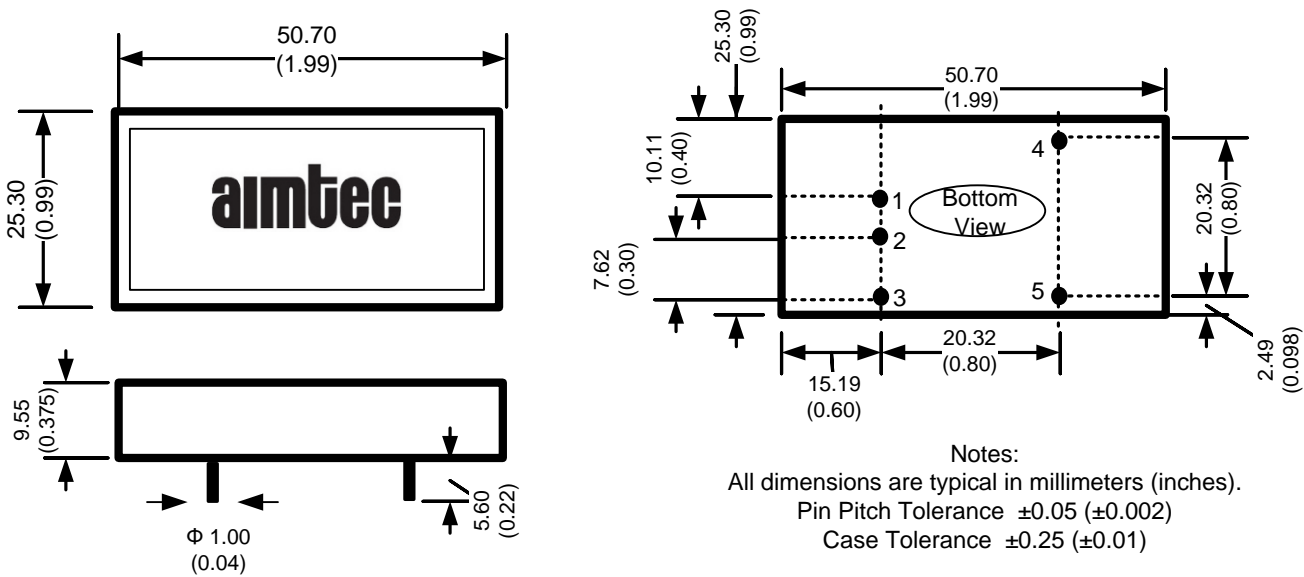

Pin	Single
1	+Vin
2	-Vin
3	Remote On/Off & PWM Dimming
4	LED +
5	LED -

Efficiency versus Input Voltage

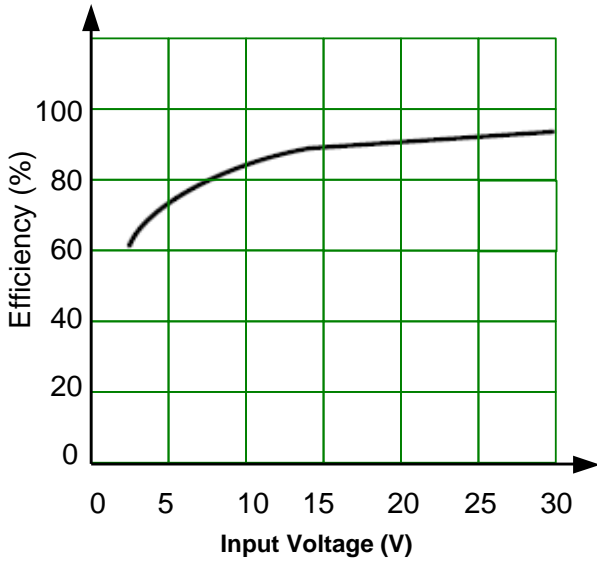

Derating

Free Air Convection

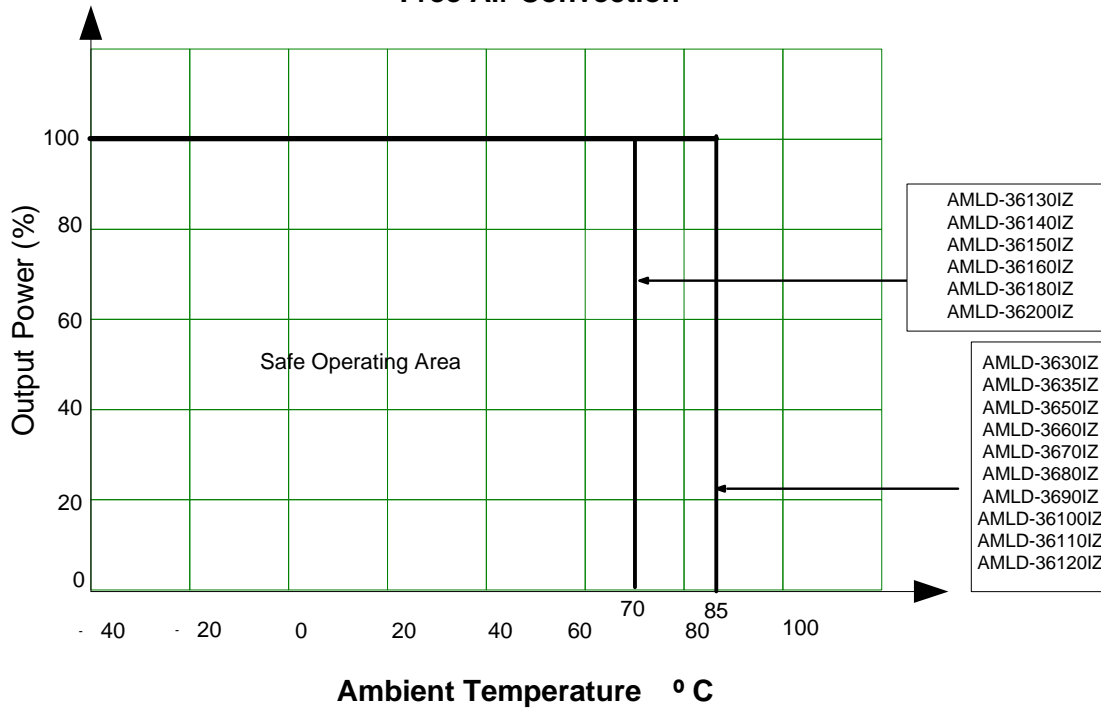

Application Circuit

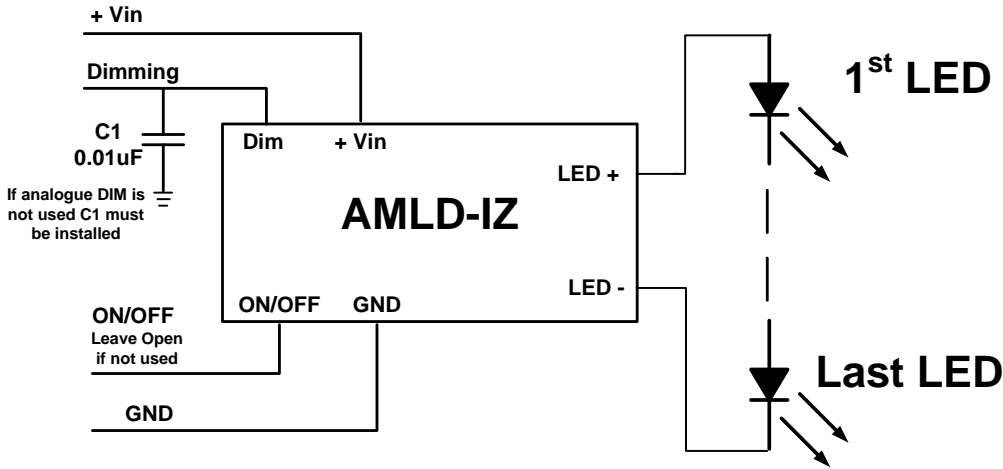

Note: The relation between input and output voltage for AMLD-IZ LED Driver step-down converter series is:
 $V_{in} - 4V \geq V_{out} \geq \text{Total LED voltage}$
 $V_{out} / \text{LED voltage} = \text{LED quantity}$

Output Current versus Dimming Voltage

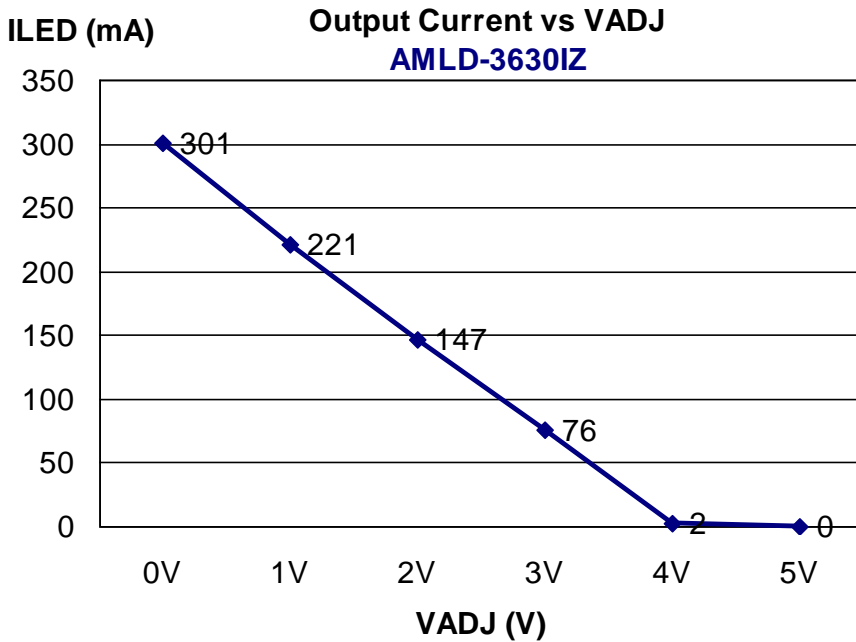

Output Current versus Dimming Voltage (continued)

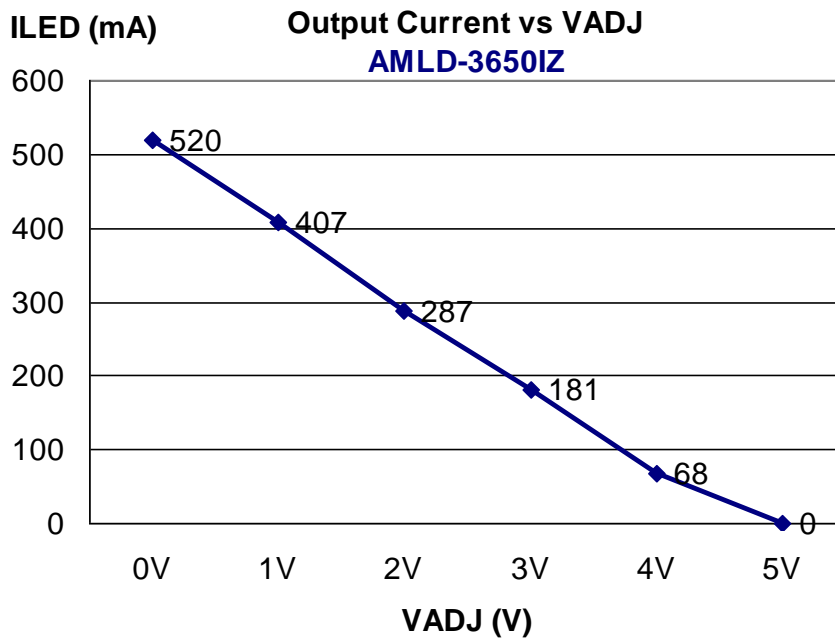
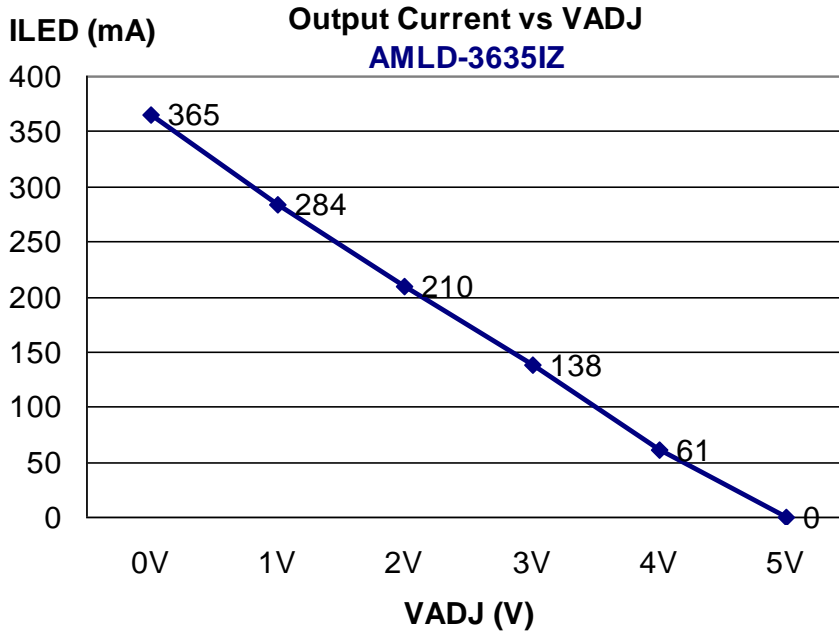

Output Current versus Dimming Voltage (continued)

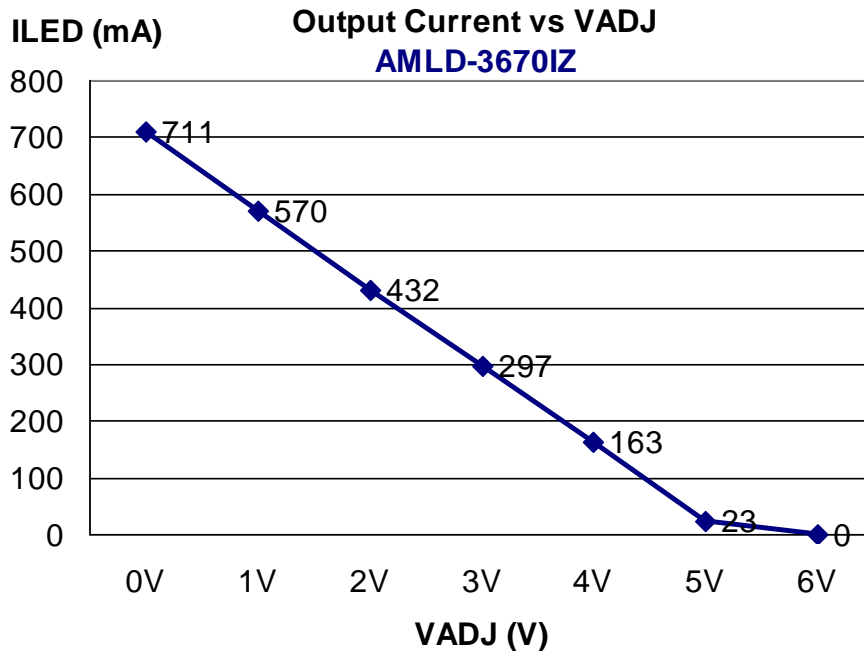
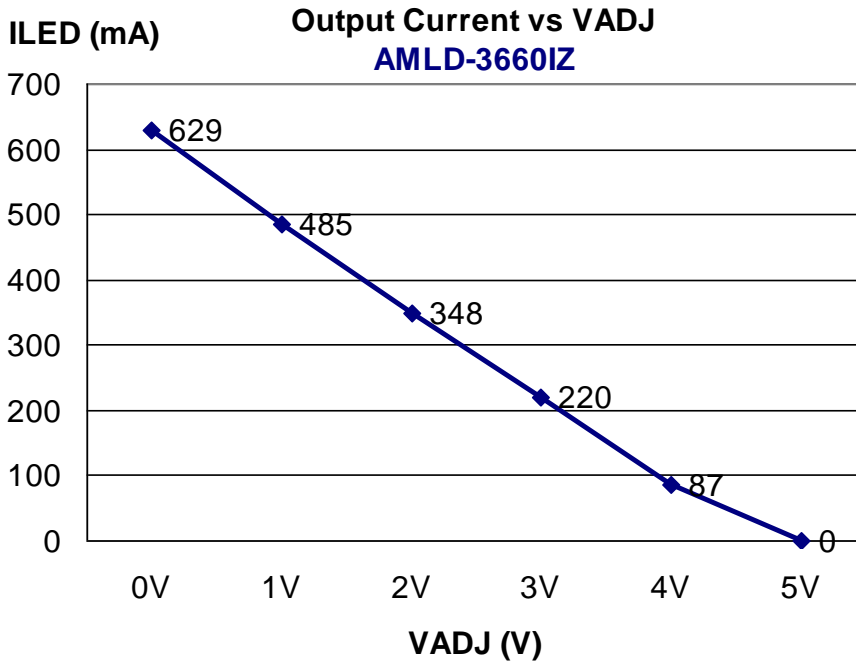

Output Current versus Dimming Voltage (continued)

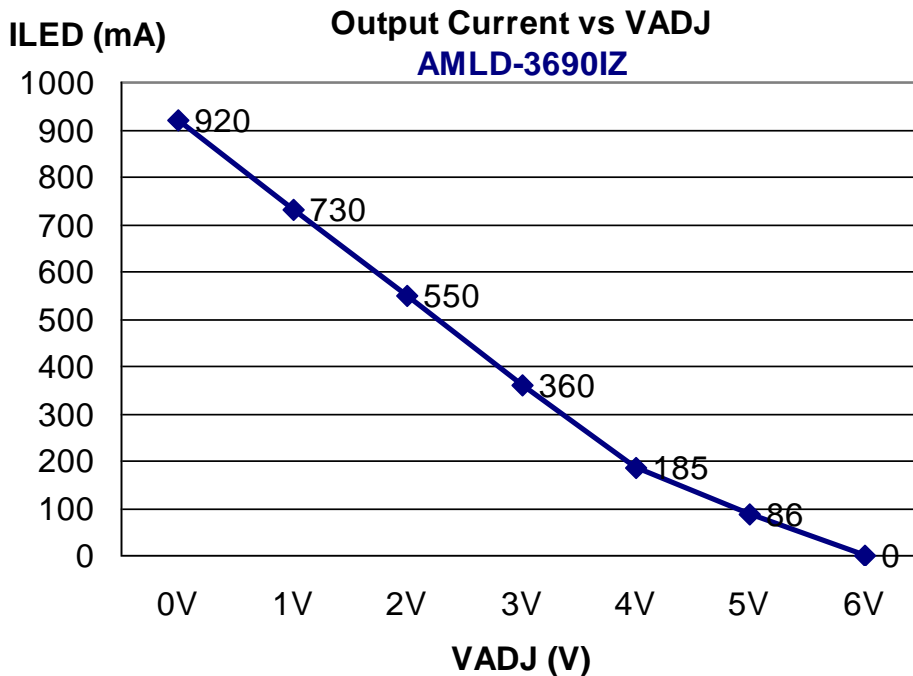
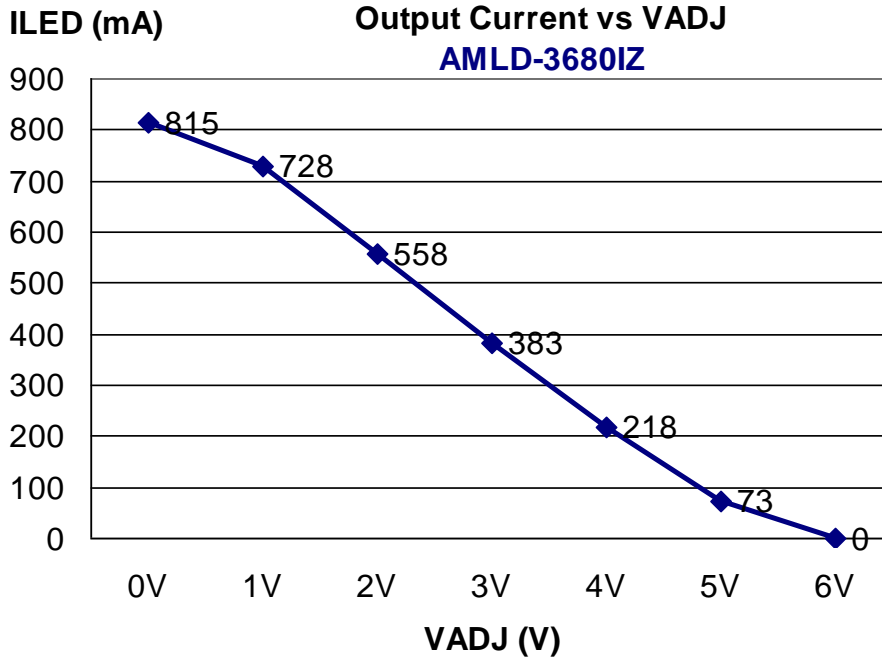

Output Current versus Dimming Voltage (continued)

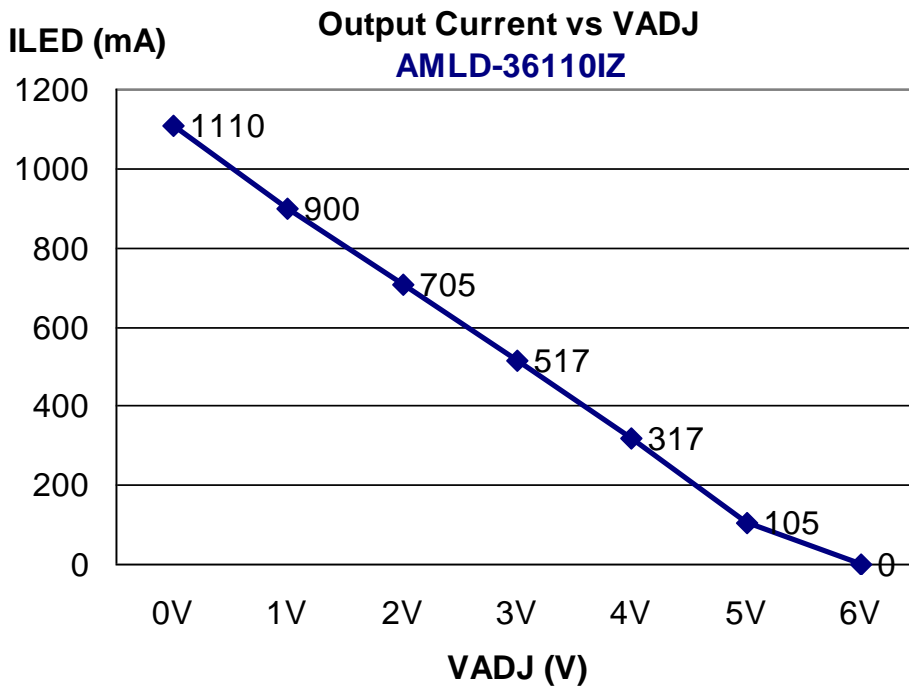
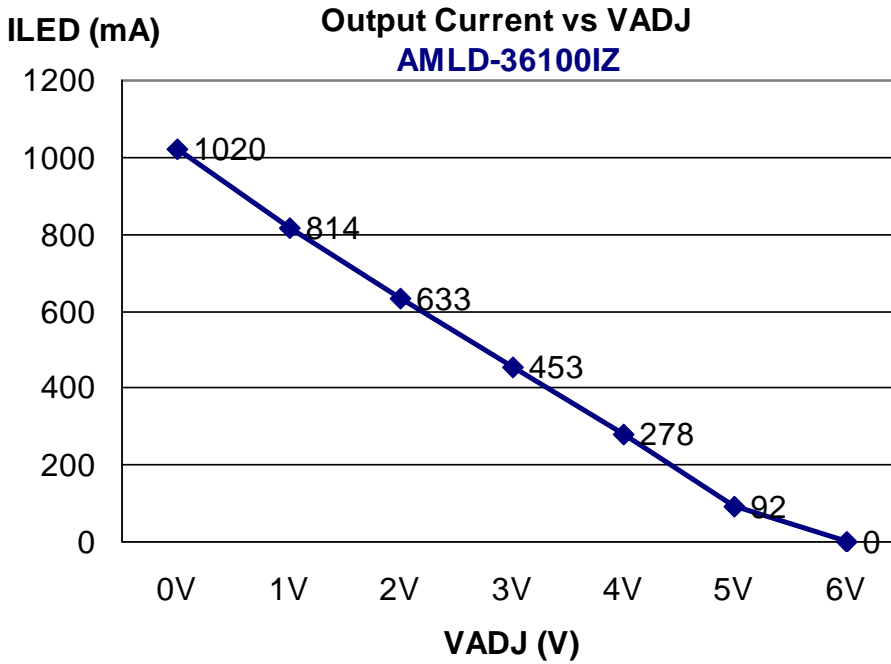

Output Current versus Dimming Voltage (continued)

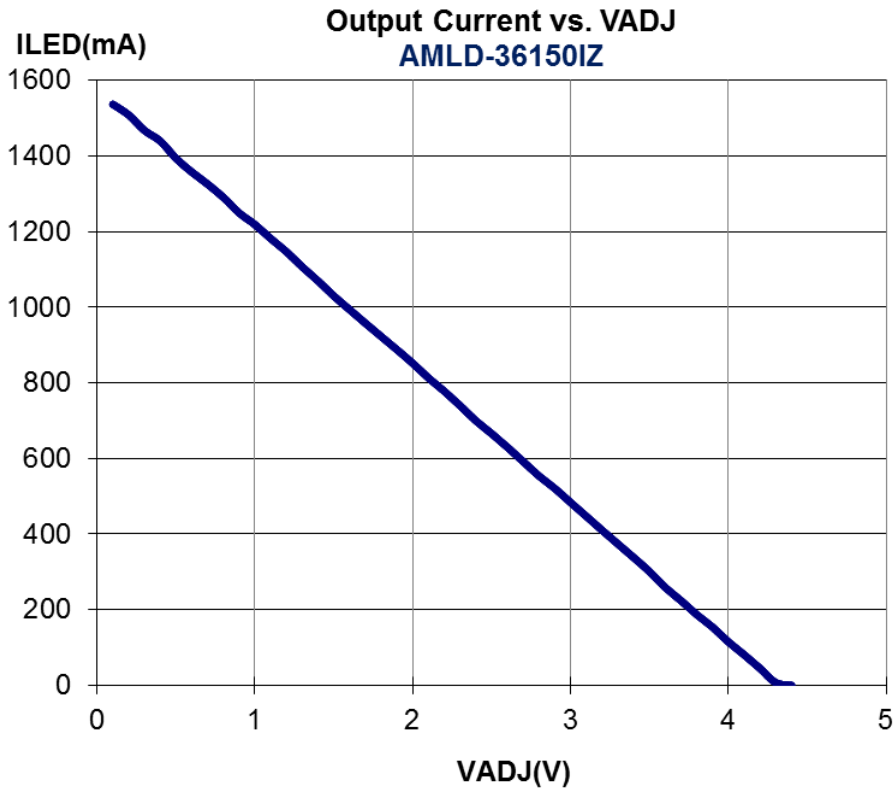
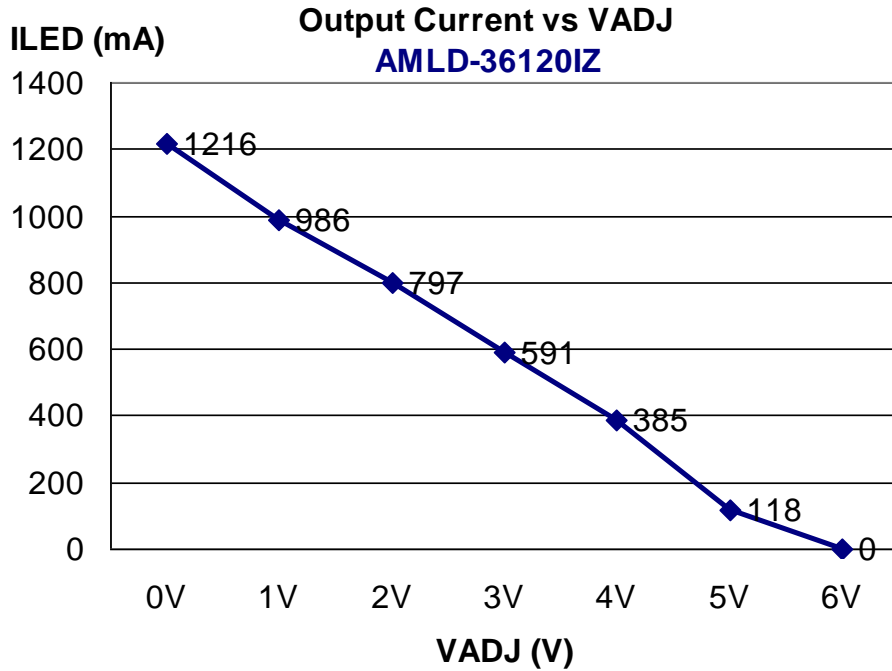

Output Current versus Dimming Voltage (continued)

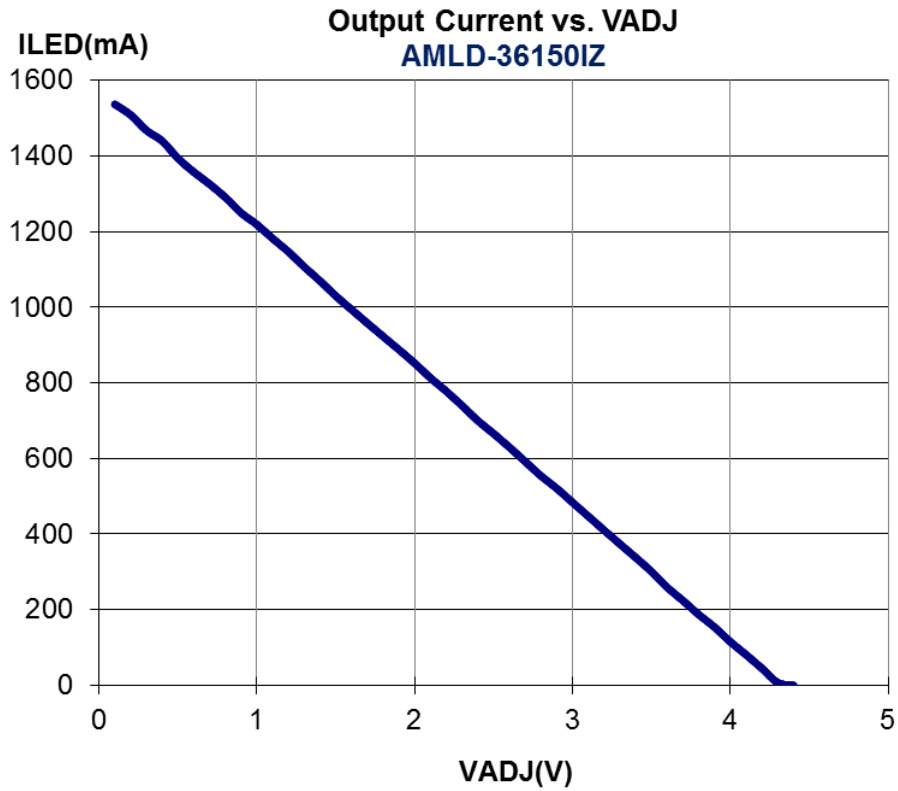
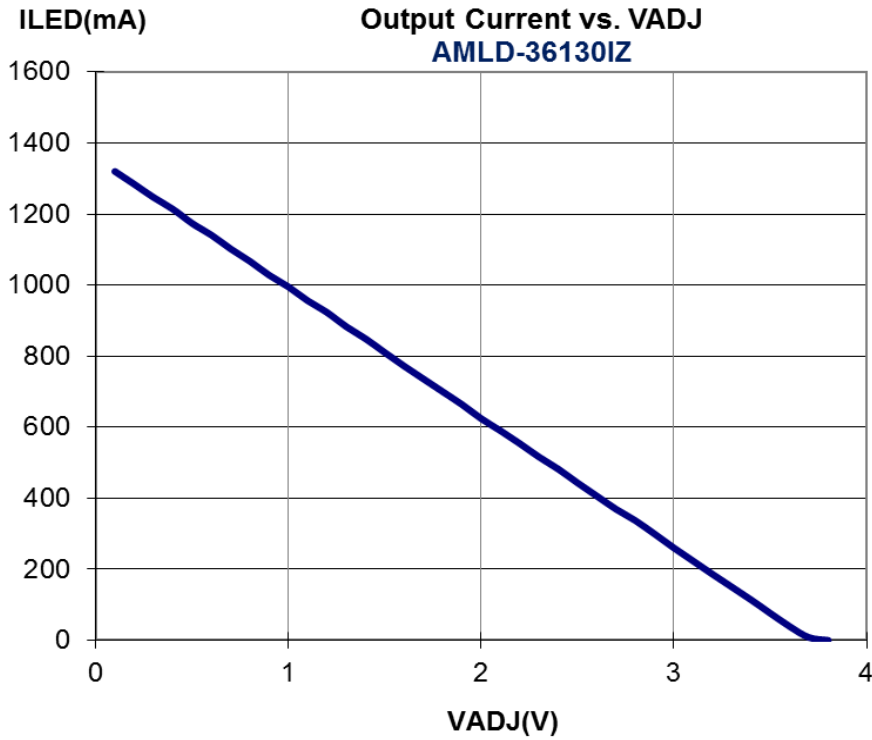

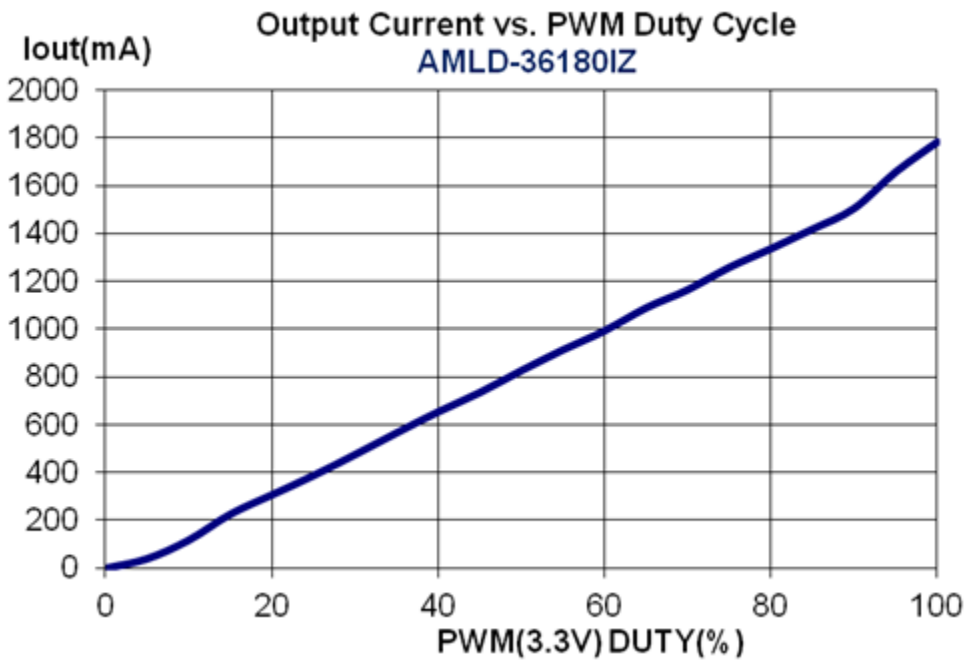
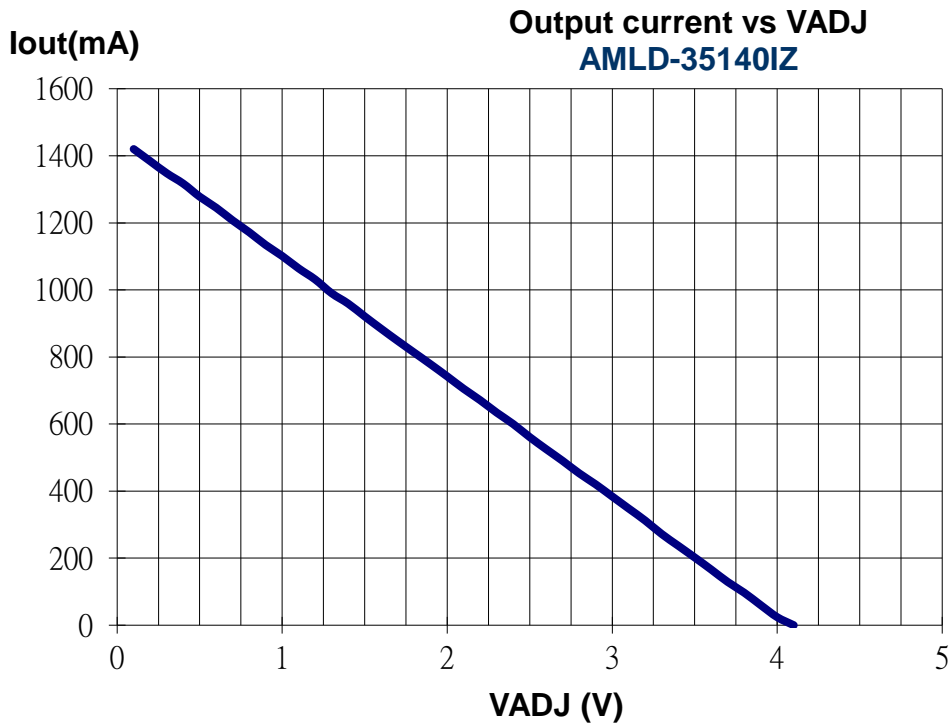

Output Current versus Dimming Voltage (continued)

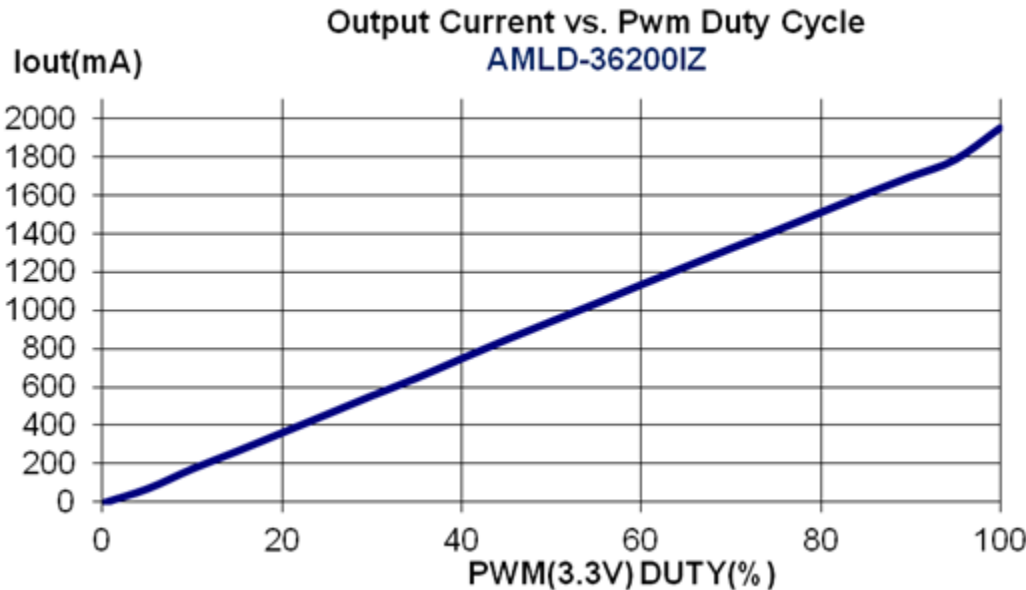
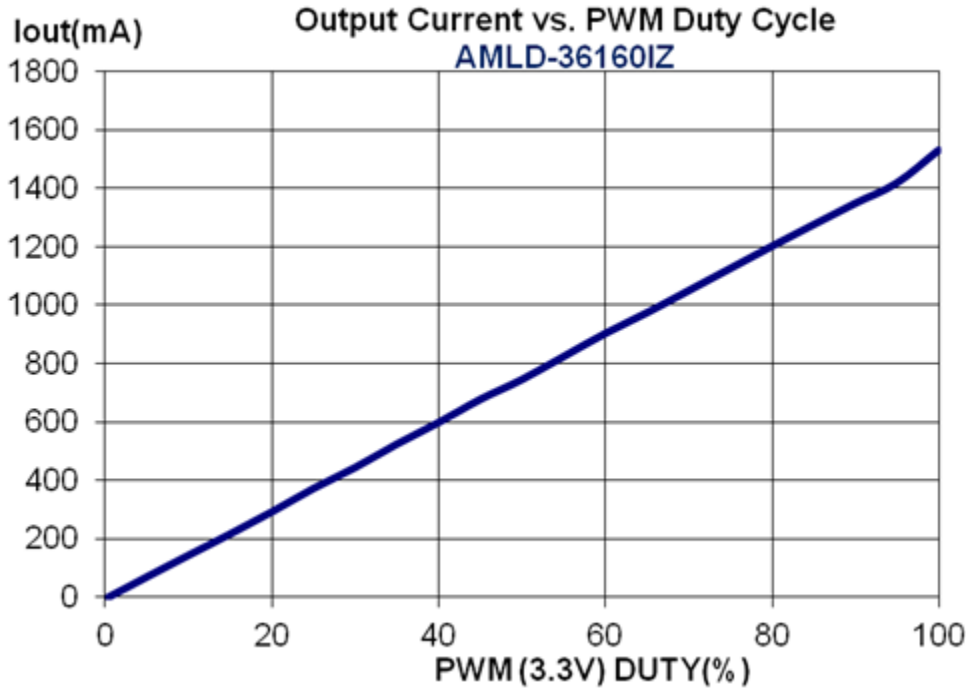

NOTE: **1.** Datasheets are updated as needed and as such, specifications are subject to change without notice. Once printed or downloaded, datasheets are no longer controlled by Aimtec; refer to www.aimtec.com for the most current product specifications. **2.** Product labels shown, including safety agency certifications on labels, may vary based on the date manufactured. **3.** Mechanical drawings and specifications are for reference only. **4.** All specifications are measured at an ambient temperature of 25°C, humidity < 75%, nominal input voltage and at rated output load unless otherwise specified. **5.** Aimtec may not have conducted destructive testing or chemical analysis on all internal components and chemicals at the time of publishing this document. CAS numbers and other limited information are considered proprietary and may not be available for release. **6.** This product is not designed for use in critical life support systems, equipment used in hazardous environments, nuclear control systems or other such applications which necessitate specific safety and regulatory standards other than the ones listed in this datasheet. **7.** Warranty is in accordance with Aimtec's standard Terms of Sale available at www.aimtec.com.