

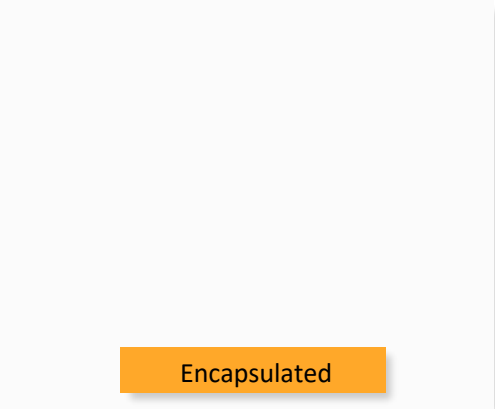

**AM150W-NZ**



Encapsulated

The AM150W-NZ series is designed to offer an ultra-thin solution to customers with designs that have challenging height considerations. The AM150W-NZ series is available in both SIP and DIP packages with open frame and metal case options. The total height of 0.23inches (5.8 mm) for the Dual inline Package offers significant space optimization when compared to typical 10W DIP products with approximately twice the height (~0.4inches).

In addition, the AM150W-NZ offers an impressive 500VAC/1500VDC isolation with a 4:1 input voltage range of 9-36VDC and up to 89% efficiency. It is also designed with input under-voltage protection, output over-voltage, over-current, short circuit protection, which enable the AM150W-NZ series to be used in a variety of application related to industrial control, instrumentation and communication equipment.

**Features**



- Wide 4:1 Input Range: 9VDC – 75VDC
- Operating Temp: -40 °C to +85 °C
- Low ripple & noise, up to 100mV(p-p) max
- Efficiency up to 89%
- I/O isolation test voltage: 1.5KVDC
- Output short circuit, over current protection, over voltage protection
- Regulated Output
- Optional package: DIP/SMD

**Summary**

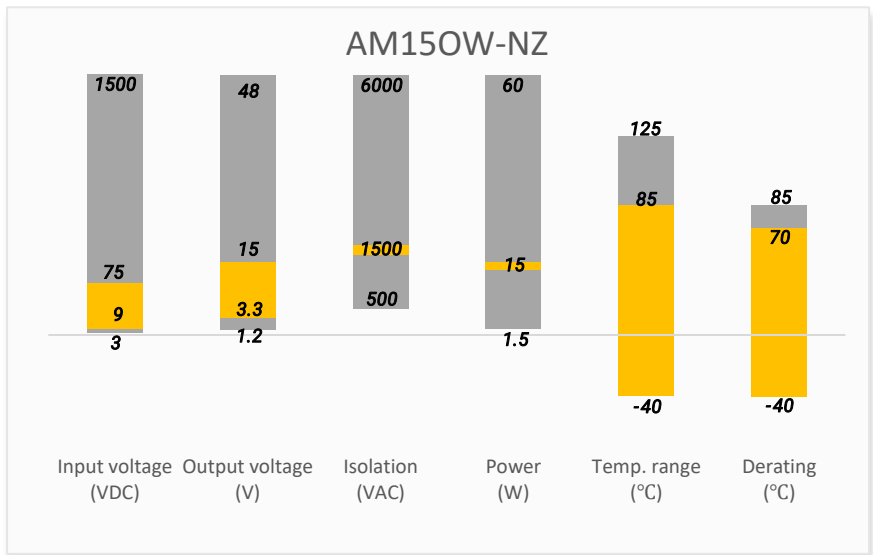

**Training**

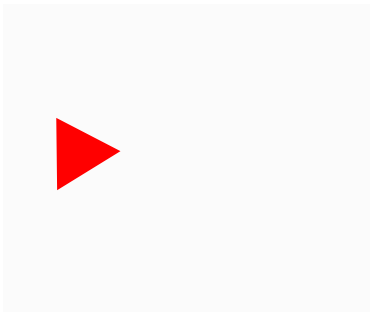

Product Training Video  
(click to open)

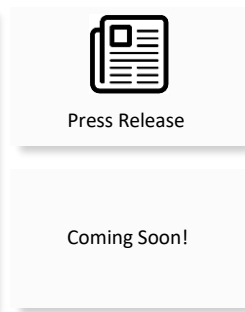

Application Notes

**Applications**



Power Grid



Industrial



Telecom



Instrumentation

## Models & Specifications

### Single Output

Model	Input Voltage (VDC)	Output Voltage (VDC)	Input Current Max (mA)		Output Current Max (mA)	Maximum Capacitive Load (μF)	Efficiency (%) Full Load
			No Load	Full Load			
AM15OW-2403SNZ	24 (9 ~ 36)	3.3	60	727	4500	4700	88
AM15OW-2405SNZ	24 (9 ~ 36)	5	60	727	3000	4700	88
AM15OW-2412SNZ	24 (9 ~ 36)	12	30	718	1250	1000	89
AM15OW-2415SNZ	24 (9 ~ 36)	15	30	718	1000	820	89
AM15OW-4803SNZ	48 (18 ~ 75)	3.3	45	363	4500	4700	88
AM15OW-4805SNZ	48 (18 ~ 75)	5	45	363	3000	4700	88
AM15OW-4812SNZ	48 (18 ~ 75)	12	25	360	1250	1000	89
AM15OW-4815SNZ	48 (18 ~ 75)	15	25	360	1000	820	89

The standard part number is for DIP and open-frame package;

With adding suffix "-M" for DIP package with metal case (E.g. AM15OW-1205SNZ-M is for 5V model with DIP pin type and metal case);  
 With adding suffix "-L" for SMD and open-frame package (E.g. AM15OW-1205SNZ-L is for 5V model with SMD pin type and open frame);  
 With adding suffix "-LM" for SMD package with metal case (E.g. AM15OW-1205SNZ-LM is for 5V model with SMD pin type and metal case).

### Input Specification

Parameters	Conditions	Typical	Maximum	Units
Voltage range	See models table			VDC
Filter	Pi filter			
Absolute maximum rating	1 sec. max	24V input models	50	VDC
		48V input models	100	
Reflected ripple current		30		mA pk-pk
Inrush current	24V input models		3000	mA
	48V input models		1500	
Start-up voltage	24V input models		9	VDC
	48V input models		18	
Input under voltage lockout	24V input models	6.5		VDC
	48V input models	15.5		
On/Off Control *	ON – 0 to 1.2Vdc, pulled low to GND or open; OFF – 3.5~12Vdc or pulled high, idle current 6mA typ.			
Alarm	Valm (relative to GND), when UVP is going to happen and during the OVP working status	0.2	1.2	VDC
	Valm (relative to GND), other working status	3.5 ~ 9		

\* The Ctrl pin voltage is referenced to input GND.

### Isolation Specification

Parameters	Conditions	Typical	Maximum	Units
Tested I/O voltage	60 sec, 1mA max	1500		VDC
Tested case to I/O voltage	60 sec, 1mA max, for metal case models	500		VDC
Resistance	500Vdc	≥ 100		MΩ
Capacitance	I/O capacitance at 100KHz/0.1V	1000		pF

Output Specification					
Parameters	Conditions	Typical	Maximum	Units	
Voltage accuracy	0 ~ 100% load	± 1	± 2	%	
Line regulation	Full load	± 0.2	± 0.5	%	
Load regulation	5 ~ 100% load	± 0.5	± 1	%	
Over voltage protection			160	% Vout	
Over current protection		180	230	% Iout	
Short circuit protection	Continuous, Auto recovery				
Temperature coefficient	Full load		± 0.03	%/°C	
Ripple & Noise*	20MHz bandwidth, 5 ~ 100% load	50	100	mV pk-pk	
Transient recovery time	25% load step change	300	500	µS	
Transient response deviation	25% load step change	3.3V,5V output models	± 3	± 8	%
		Others	± 3	± 5	

\* Ripple and Noise are measured at 20MHz bandwidth by using a 1µF (M/C) and 10µF (E/C) parallel capacitor and typical input with full load

General Specifications				
Parameters	Conditions	Typical	Maximum	Units
Switching frequency	100% load	300		KHz
Operating temperature	See derating graph	-40 to +85		°C
Storage temperature		-55 to +125		°C
Reflow soldering temperature	Peak temp ≤ 245°C, 60 sec max at 217°C, please refer to IPC/JEDEC J-STD-020D.1.			
Soldering temperature	1.5mm from case 10 sec max		300	°C
Cooling	Free air convection (20 LFM)			
Humidity	Non-condensing		95	% RH
Case material	Aluminum alloy			
Vibration	10-150Hz, 5G, 60min. along X,Y and Z			
Weight	Open-frame models	3.3V,5V output models	11.0	g
		Others	8.8	
	Metal case models	3.3V,5V output models	13.8	g
		Others	11.5	
Dimensions (L x W x H)	Standard DIP and open-frame package	3.3V,5V output models	1.52 x 1.07 x 0.24 inches, 38.70 x 27.20 x 6.20mm	
		Others	1.52 x 1.07 x 0.23 inches, 38.70 x 27.20 x 5.80mm	
	Optional SMD and open-frame package	3.3V,5V output models	1.57 x 1.07 x 0.24 inches, 39.90 x 27.20 x 6.20mm	
		Others	1.57 x 1.07 x 0.23 inches, 39.90 x 27.20 x 5.80mm	
	Optional DIP package with metal case	3.3V,5V output models	1.54 x 1.16 x 0.27 inches, 39.10 x 29.50 x 6.80mm	
		Others	1.54 x 1.16 x 0.25 inches, 39.10 x 29.50 x 6.40mm	
Optional SMD package with metal case	3.3V,5V output models	1.57 x 1.16 x 0.27 inches, 39.90 x 29.50 x 6.80mm		
	Others	1.57 x 1.16 x 0.25 inches, 39.90 x 29.50 x 6.40mm		
MTBF	> 1 000 000 hrs (MIL-HDBK -217F, t=+25°C) / Full Load			

**Safety Specifications**

Parameters

Standards	Designed to meet UL/IEC/EN 62368	
	EMC - Conducted and radiated emission	EN55032/CISPR32, CLASS B with recommended circuit
	Electrostatic Discharge Immunity	IEC 61000-4-2, Contact $\pm 6\text{KV}$ , Criteria B
	RF, Electromagnetic Field Immunity	IEC 61000-4-3, 10V/m, Criteria A
	Electrical Fast Transient/Burst Immunity	IEC 61000-4-4, $\pm 2\text{KV}$ , Criteria B with recommended circuit
	Surge Immunity	IEC 61000-4-5, L-L $\pm 2\text{KV}$ , Criteria B with recommended circuit
	RF, Conducted Disturbance Immunity	IEC 61000-4-6, 3Vr.m.s, Criteria A

**Derating**

**3.3V,5V output models**

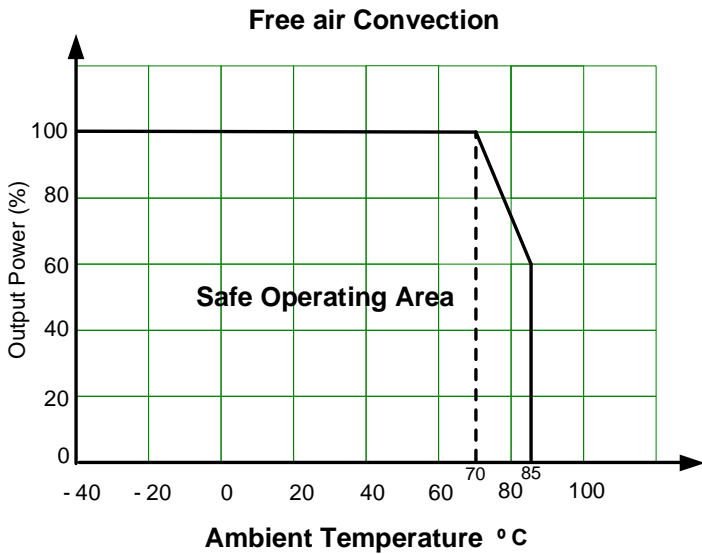

**12V,15V output models**

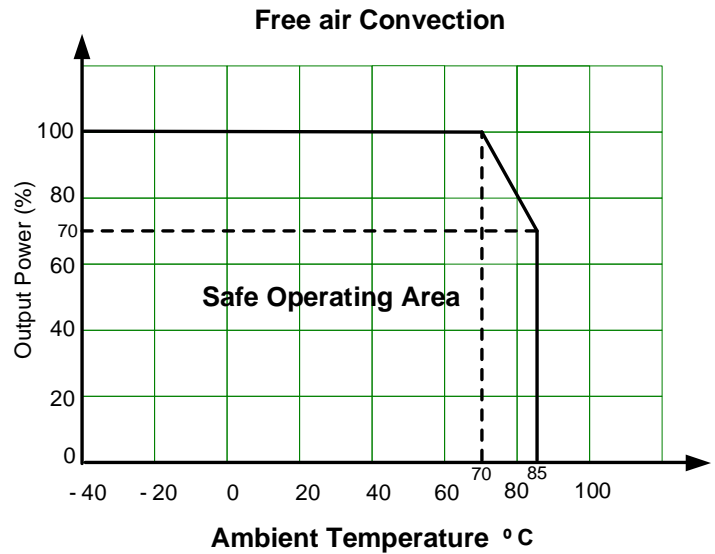

## Typical Application Circuit

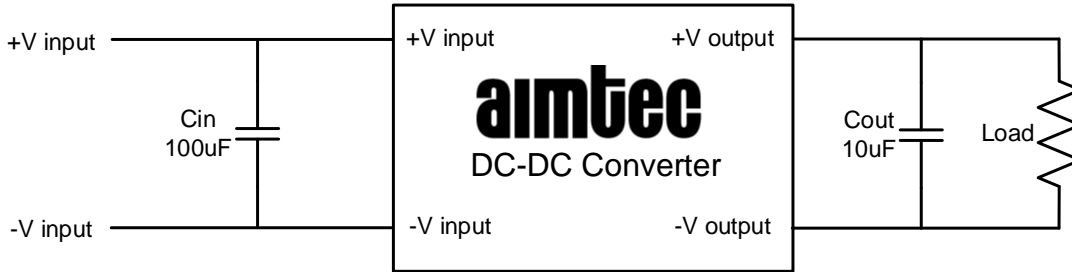

## EMC Recommended Circuit

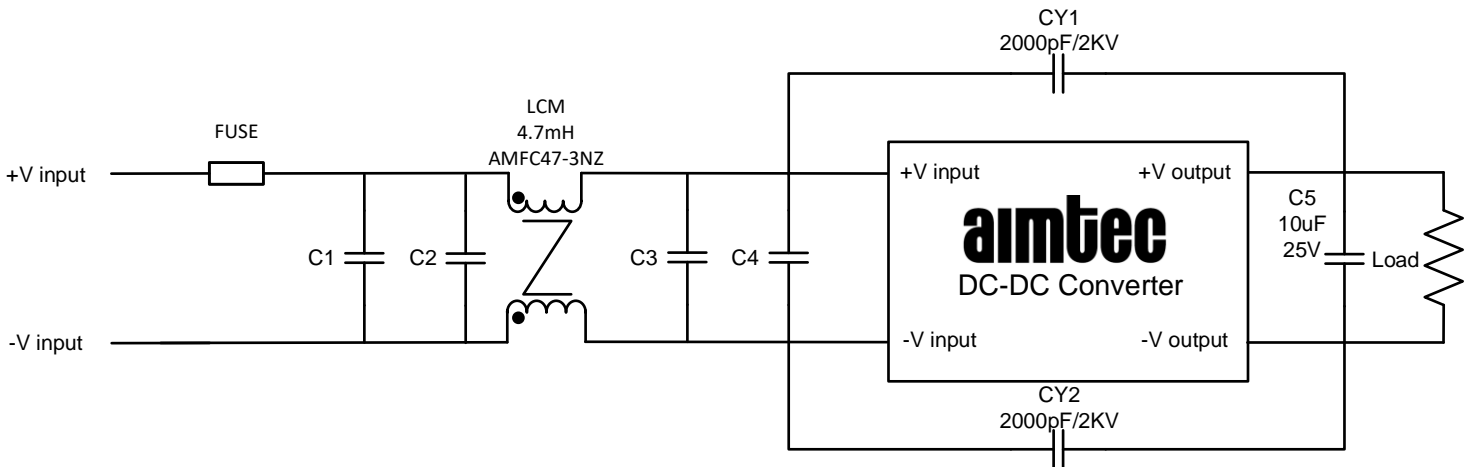

Model	24V input models	48V input models
Fuse	Choose according to actual input current	
C1	470uF/50V	470uF/100V
C2,C3	4.7uF/50V	4.7uF/100V
C4	330uF/50V	330uF/100V

Note: The package with case model, the case should be connected to input pin GND when testing EMC performance.

Dimensions

Standard DIP and open-frame package models

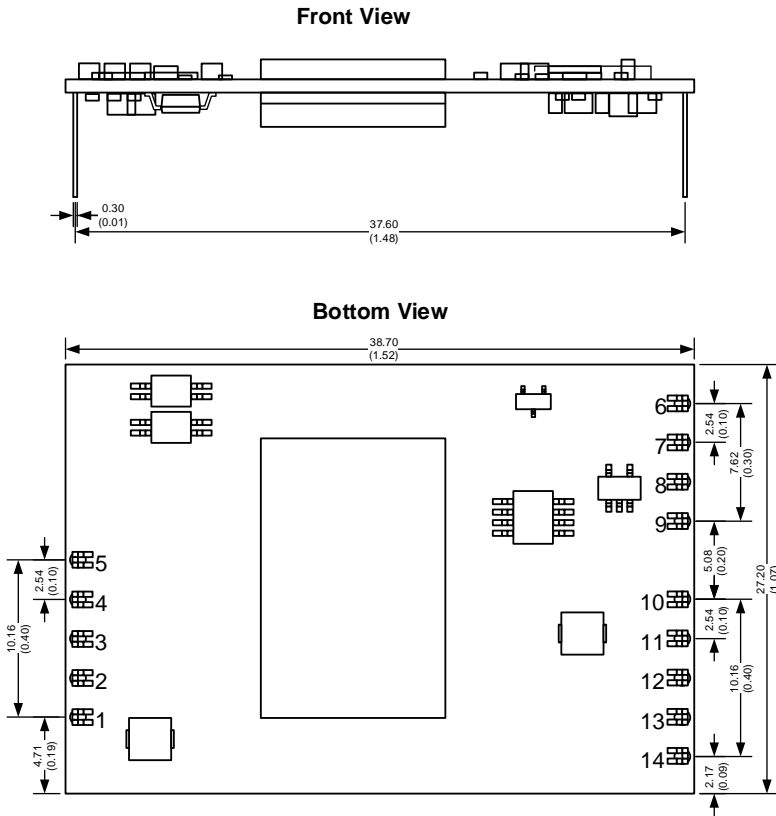

Notes:  
All dimensions are typical in millimeters (inches).  
Pin section tolerance :  $\pm 0.1$  ( $\pm 0.004$ )  
Stand-off tolerance  $\pm 0.50$  ( $\pm 0.02$ )

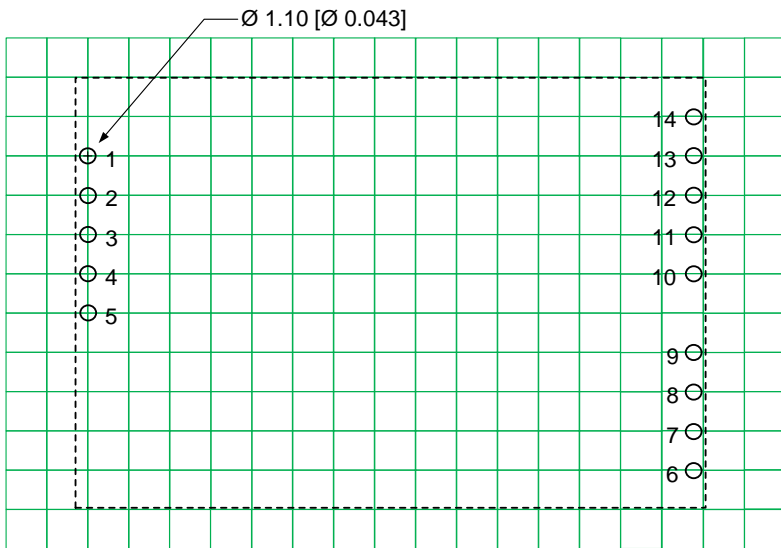

Note : Grid 2.54\*2.54 mm

Pin Out Specifications	
Pin	Single
1	+V Output
2	+V Output
3	+V Output
4	-V Output
5	-V Output
6	NC
7	ALM
8	Ctrl
9	NC
10	+V Input
11	+V Input
12	-V Input
13	-V Input
14	NC

### Optional DIP package with metal case models

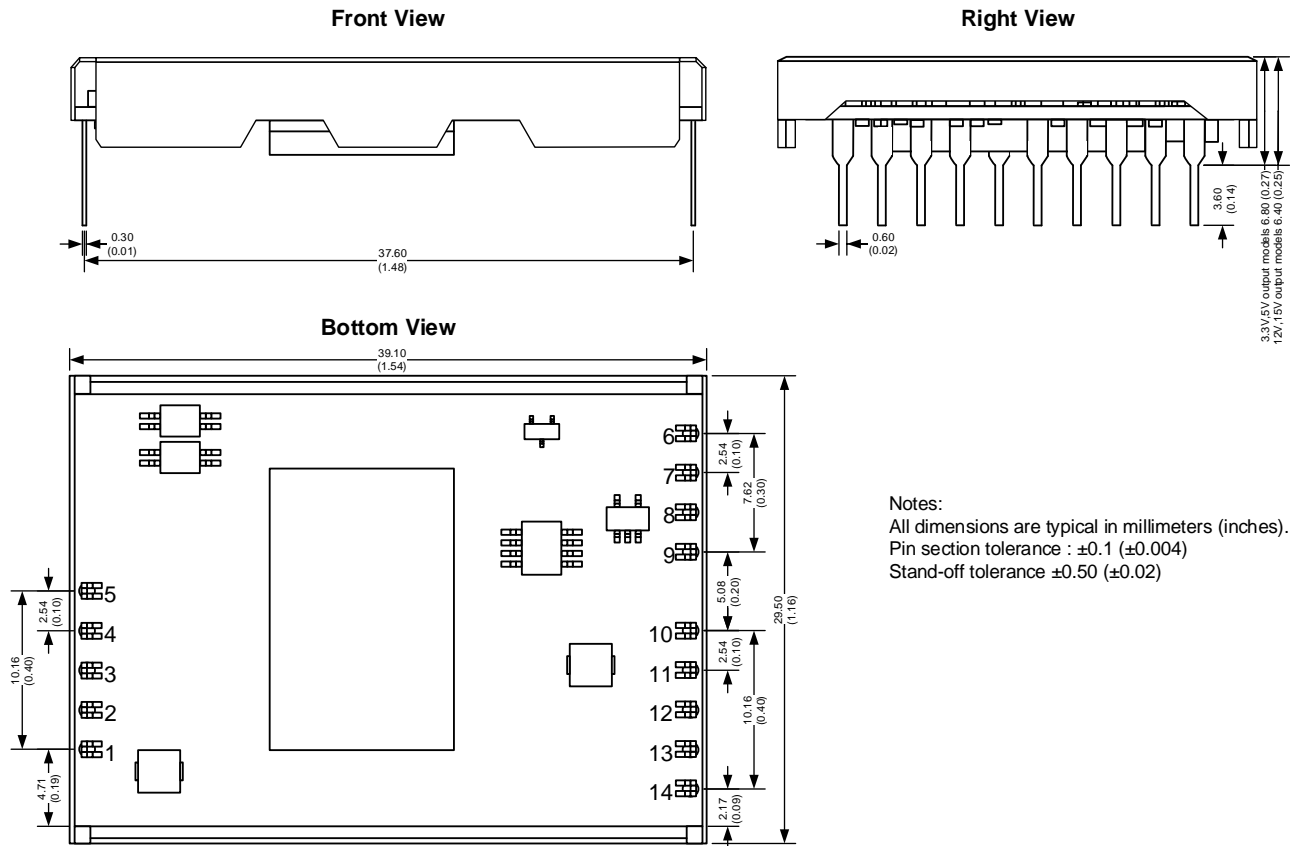

Notes:  
All dimensions are typical in millimeters (inches).  
Pin section tolerance :  $\pm 0.1$  ( $\pm 0.004$ )  
Stand-off tolerance  $\pm 0.50$  ( $\pm 0.02$ )

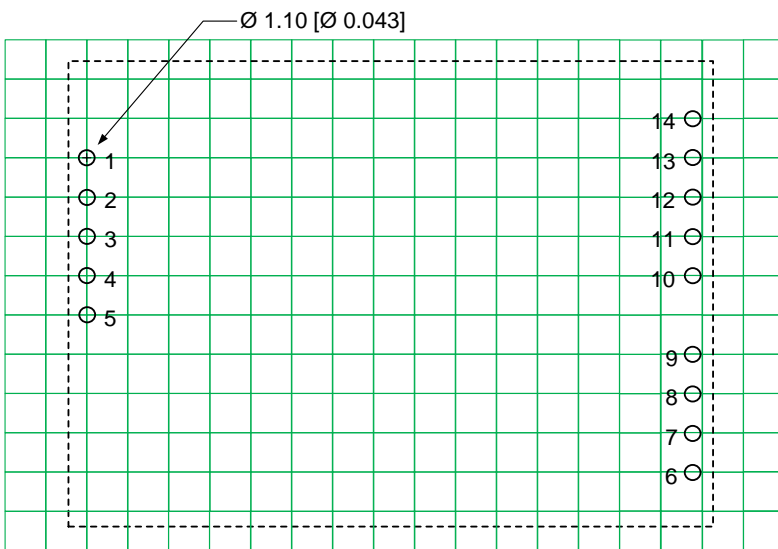

Note : Grid 2.54\*2.54 mm

Pin Out Specifications	
Pin	Single
1	+V Output
2	+V Output
3	+V Output
4	-V Output
5	-V Output
6	NC
7	ALM
8	Ctrl
9	NC
10	+V Input
11	+V Input
12	-V Input
13	-V Input
14	NC

## Optional SMD and open-frame package models

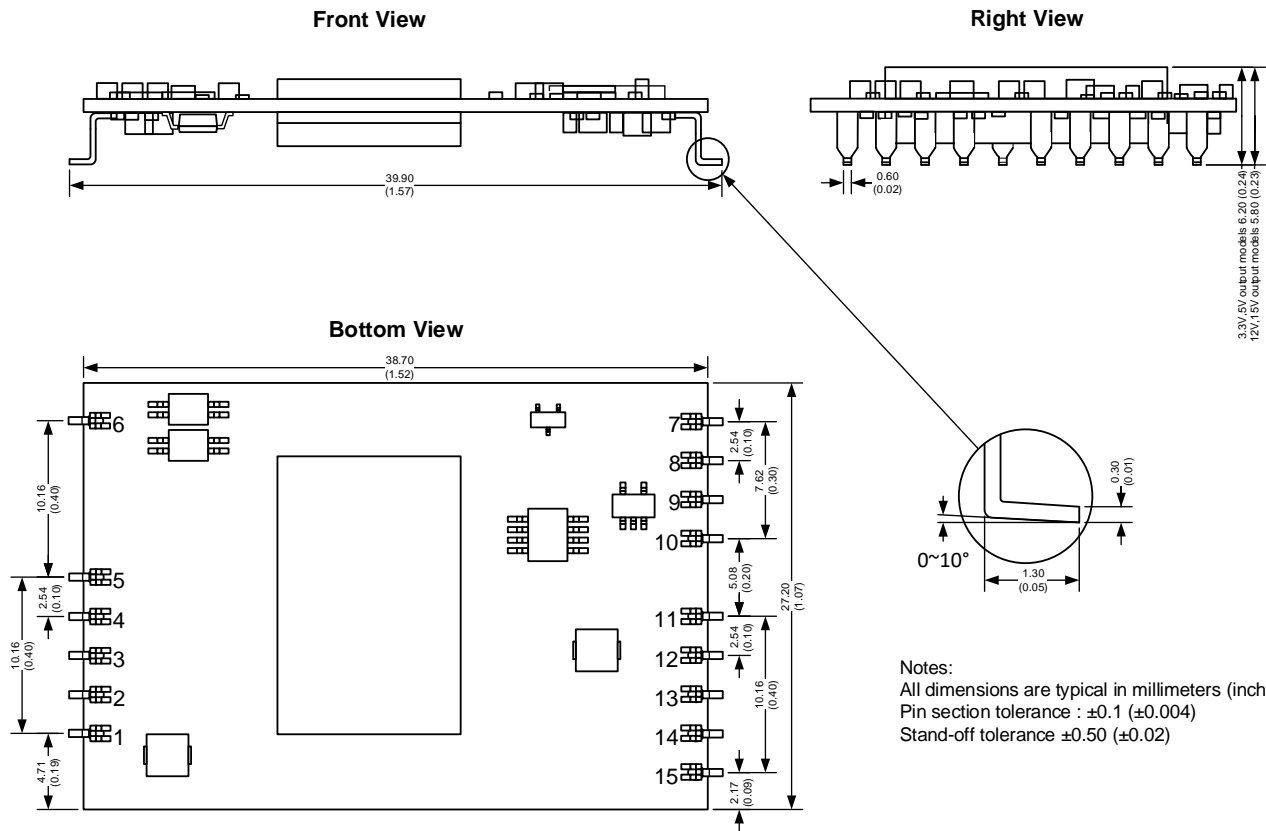

**Notes:**

All dimensions are typical in millimeters (inches).  
Pin section tolerance :  $\pm 0.1$  ( $\pm 0.004$ )  
Stand-off tolerance  $\pm 0.50$  ( $\pm 0.02$ )

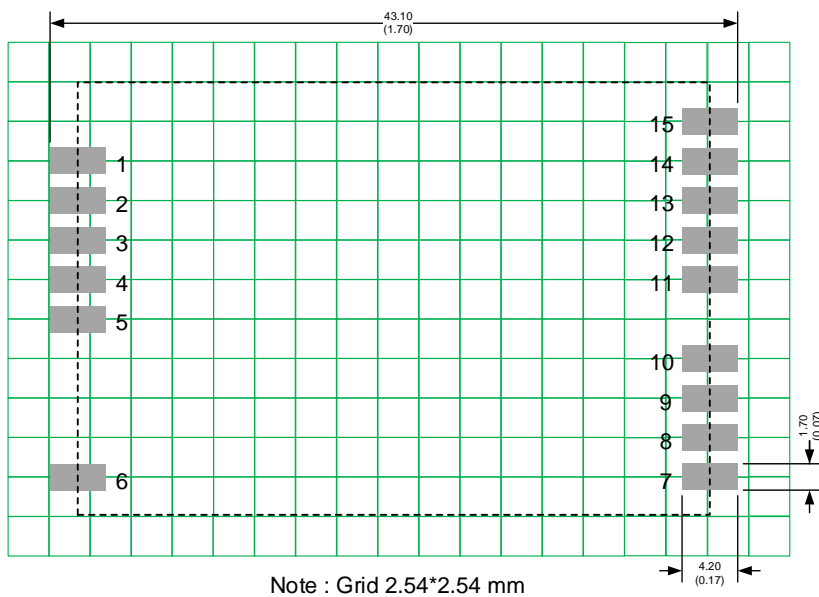

Pin Out Specifications	
Pin	Single
1	+V Output
2	+V Output
3	+V Output
4	-V Output
5	-V Output
6	NC
7	NC
8	ALM
9	Ctrl
10	NC
11	+V Input
12	+V Input
13	-V Input
14	-V Input
15	NC



## Optional SMD package with metal case models

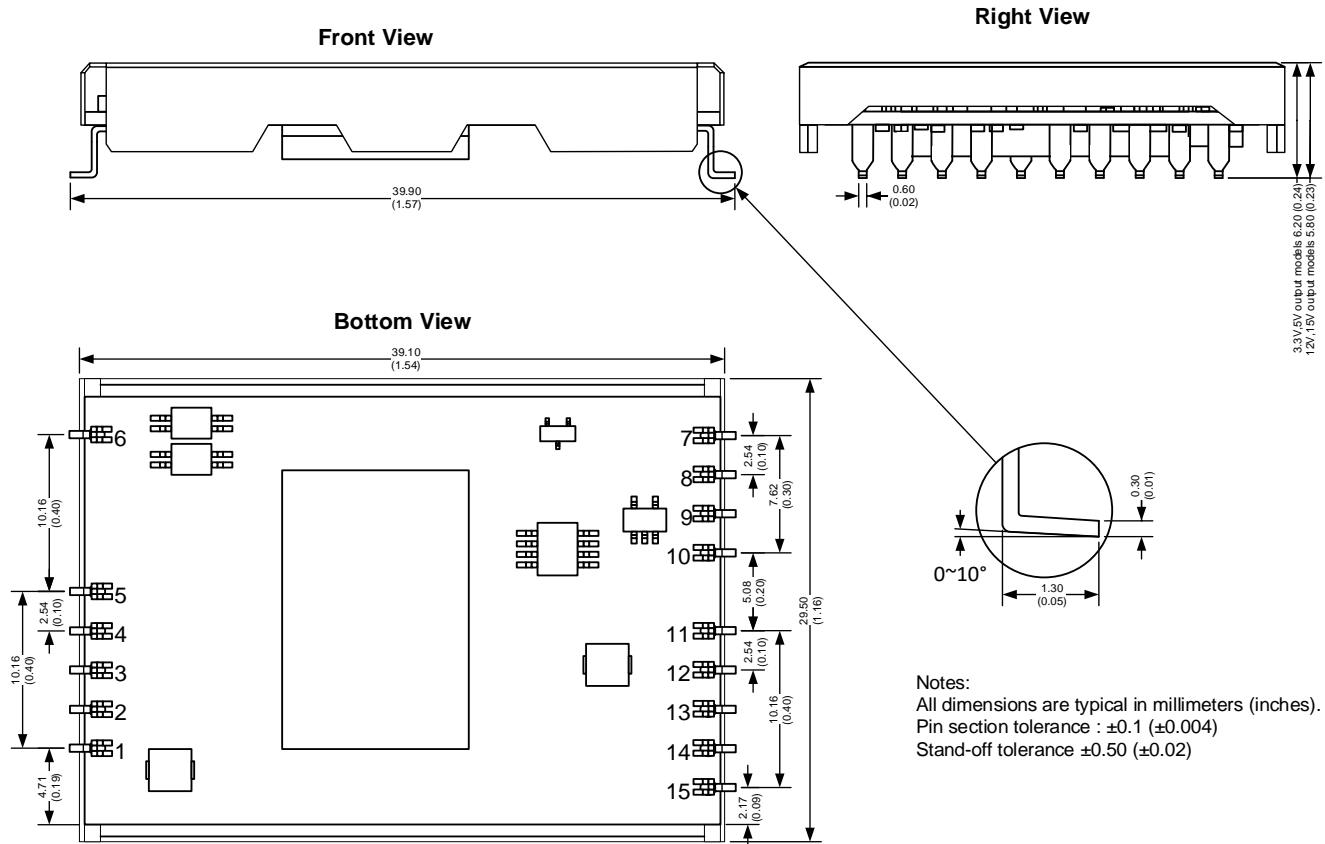

Notes:  
All dimensions are typical in millimeters (inches).  
Pin section tolerance :  $\pm 0.1$  ( $\pm 0.004$ )  
Stand-off tolerance  $\pm 0.50$  ( $\pm 0.02$ )

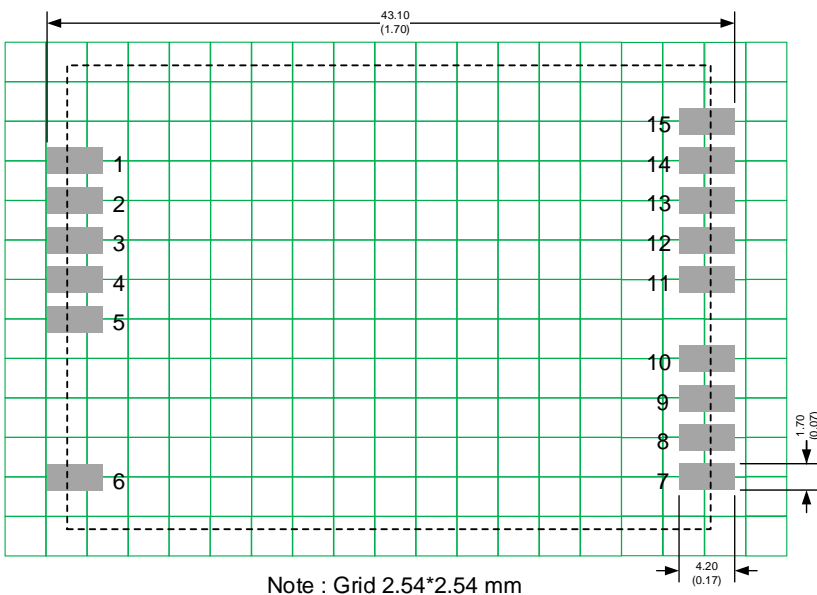

Pin Out Specifications	
Pin	Single
1	+V Output
2	+V Output
3	+V Output
4	-V Output
5	-V Output
6	NC
7	NC
8	ALM
9	Ctrl
10	NC
11	+V Input
12	+V Input
13	-V Input
14	-V Input
15	NC

**NOTE:** **1.** Datasheets are updated as needed and as such, specifications are subject to change without notice. Once printed or downloaded, datasheets are no longer controlled by Aimtec; refer to [www.aimtec.com](http://www.aimtec.com) for the most current product specifications. **2.** Product labels shown, including safety agency certifications on labels, may vary based on the date manufactured. **3.** Mechanical drawings and specifications are for reference only. **4.** All specifications are measured at an ambient temperature of 25°C, humidity<75%, nominal input voltage and at rated output load unless otherwise specified. **5.** Aimtec may not have conducted destructive testing or chemical analysis on all internal components and chemicals at the time of publishing this document. CAS numbers and other limited information are considered proprietary and may not be available for release. **6.** This product is not designed for use in critical life support systems, equipment used in hazardous environments, nuclear control systems or other such applications which necessitate specific safety and regulatory standards other the ones listed in this datasheet. **7.** Warranty is in accordance with Aimtec's standard Terms of Sale available at [www.aimtec.com](http://www.aimtec.com).