

**FEATURES:**

- I/O Isolation 4200VDC
- Operating temperature -40°C to + 105°C
- Rated working voltage 250Vrms/400VDC
- SMD open frame package
- Efficiency up to 78%
- High MTBF of over 7Mh



Models

Single output

Model	Input Voltage (V)	Output Voltage (V)	Output Current Max Min (mA)		Input Current Full No Load (mA)		Isolation (VDC)	Max Capacitive Load (uF)	Efficiency (%)
AM1LO-0303SH421	2.97-3.63	3.3	303	30	416	50	4200	220	73
AM1LO-0305SH421	2.97-3.63	5	200	20	404	50	4200	220	75
AM1LO-0503SH421	4.5-5.5	3.3	303	30	274	40	4200	220	73
AM1LO-0505SH421	4.5-5.5	5	200	20	264	40	4200	220	76

Models

Dual output

Model	Input Voltage (V)	Output Voltage (V)	Output Current Max Min (mA)		Input Current Full No Load (mA)		Isolation (VDC)	Max Capacitive Load (uF)	Efficiency (%)
AM1LO-0303DH421	2.97-3.63	±3.3	±151	±15	404	50	4200	±100	75
AM1LO-0305DH421	2.97-3.63	±5	±100	±10	389	50	4200	±100	78
AM1LO-0503DH421	4.5-5.5	±3.3	±151	±15	267	40	4200	±100	75
AM1LO-0505DH421	4.5-5.5	±5	±100	±10	257	40	4200	±100	78

NOTE: 1. Add suffix "TR" to a part number when ordering in tape and reel package.

NOTE: 2. All specifications in this datasheet are measured at an ambient temperature of 25°C, humidity<75%, nominal input voltage and at rated output load unless otherwise specified.

Input Specifications

Parameters	Nominal	Typical	Maximum	Units
Voltage range	3.3 5	2.97-3.63 4.5-5.5		VDC
Filter	Capacitor			
Absolute Maximum Rating	3.3 Vin 5 Vin	-0.7-5 -0.7-9		VDC
Peak Input Voltage time		1		s
Input Reflected Ripple Current	3.3 & 5V Input	20		mA p-p
External fuse	Recommended slow blow type	1A for 3.3V and 500mA for 5V input models		
Startup time	Nominal Vin	20		ms

Isolation Specifications

Parameters	Conditions	Typical	Rated	Units
Tested I/O voltage	60 sec		4200	VDC
Resistance		>1000		MOhm
Capacitance		25		pF

Output Specifications

Parameters	Conditions	Typical	Maximum	Units
Voltage accuracy		See tolerance chart		
Short Circuit protection		Momentary, 0.5s		
Line voltage regulation	For ±1% of Vin		±1.2	% of Vin
Load voltage regulation	10% - 100% load	3.3V output	±15	%
		5V output	±12	
Temperature coefficient	100% load	±0.03		%/°C

Ripple & Noise*	20MHz Bandwidth	Single output	±150	mV p-p
		Dual output	±120	

*Ripple and Noise measured with a 10uF EC and 0.1uF CC.

General Specifications

Parameters	Conditions	Typical	Maximum	Units
Switching frequency		50-80		KHz
Operating temperature	With derating above +100	-40 to +105		°C
Storage temperature		-55 to +125		°C
Cooling	Free air convection (30-65LFM)			
Humidity	Non-Condensing		95	% RH
Base material	Non-conductive black plastic (UL94-V0)			
Weight	Single output models		1.52	g
	Dual output models		1.80	
Dimensions (L x W x H)	Single output models		0.50 x 0.44 x 0.27 inches x 6.85 mm	12.70 x 11.20
	Dual output models		0.60 x 0.44 x 0.27 inches x 6.85 mm	15.24 x 11.20
MTBF	>7Mhrs (MIL-HDBK -217F, Ground Benign, t=+25°C)			
Reflow temperature	10 sec max		245	°C

Environmental Specifications

Parameters		
Vibration	Test mode	Per MIL-STD-810F

Safety Specifications

Parameters		
Approval	CE, UL, IEC/EN/UL60950-1 & IEC/EN/UL62368-1	
Standards	EMI - Conducted and radiated emission	EN55032, class B (with the recommended EMI circuit)
	Electrostatic Discharge Immunity	IEC 61000-4-2: Criteria A
	RF, Electromagnetic Field Immunity	IEC 61000-4-3: Criteria A
	Electrical Fast Transient/Burst Immunity	IEC 61000-4-4: Criteria A (with the recommended EMC circuit)
	Surge Immunity	IEC 61000-4-5: Criteria A (with the recommended EMC circuit)
	RF, Conducted Disturbance Immunity	IEC 61000-4-6: Criteria A
	Power frequency Magnetic Field Immunity	IEC 61000-4-8: Criteria A

Pin Out Specifications

Pin	Single
1	- V Input
2	+ V Input
4	-V Output
5	+V Output
8	N.C.

Dimensions Single output models

Side View

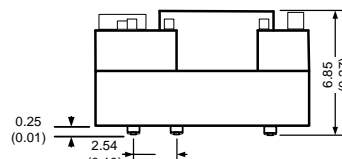

Top View

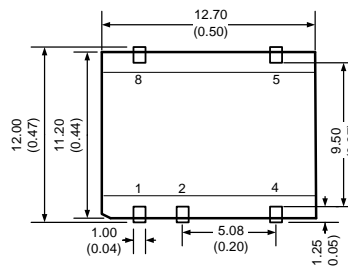

Solder pad dimensions

All dimensions are in mm (inch)
Pin Tolerance: ±0.25mm (0.01inch)
Case Tolerance: ±0.50mm (0.02inch)

Pin Out Specifications

Pin	Dual
1	- V Input
2	+ V Input
4	Common
5	-V Output
7	+V Output
10	N.C.

Dimensions

Dual output models

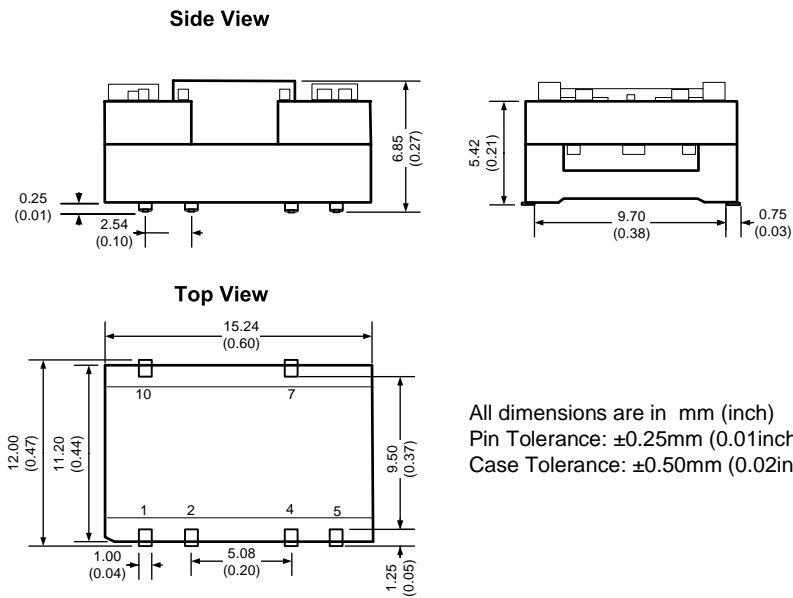

All dimensions are in mm (inch)
Pin Tolerance: $\pm 0.25\text{mm}$ (0.01inch)
Case Tolerance: $\pm 0.50\text{mm}$ (0.02inch)

Solder pad dimensions

EMI Recommended Circuit (Class B)

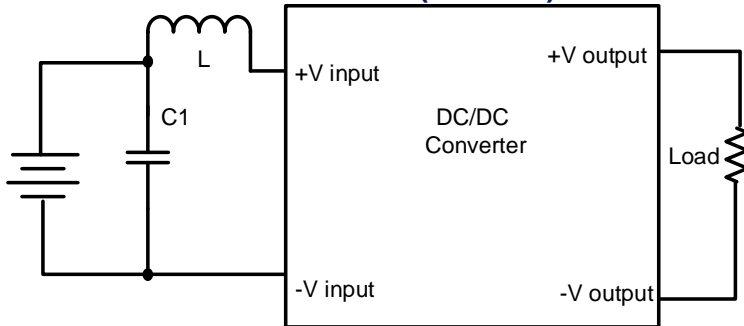

C1	L
22 μF / 10V	6.8 μH

EMC Recommended Circuit

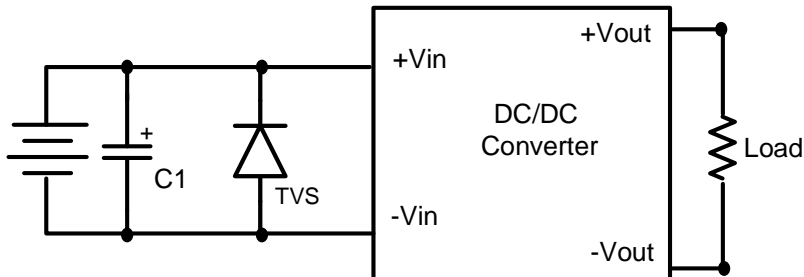

C1	TVS
330 μF / 50V	9V

Input Reflected Ripple Current Test Circuit

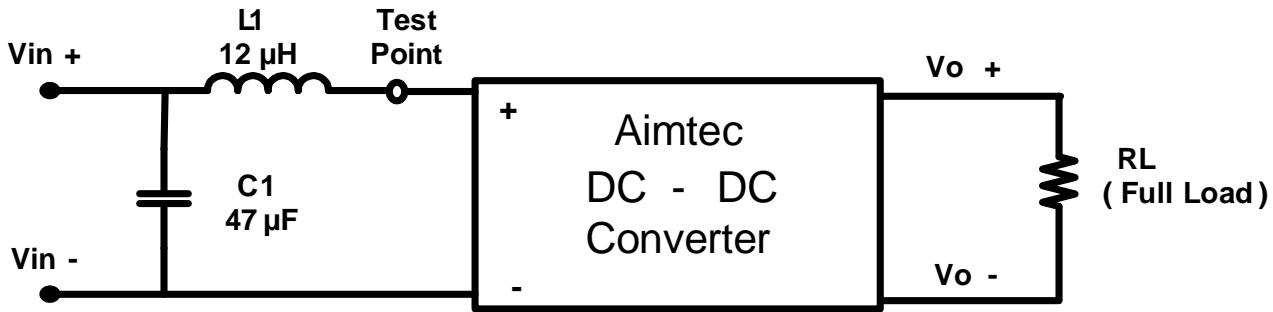

* Tested at full load and nominal input
C1 – ESR<1Ω at 100KHz

Derating

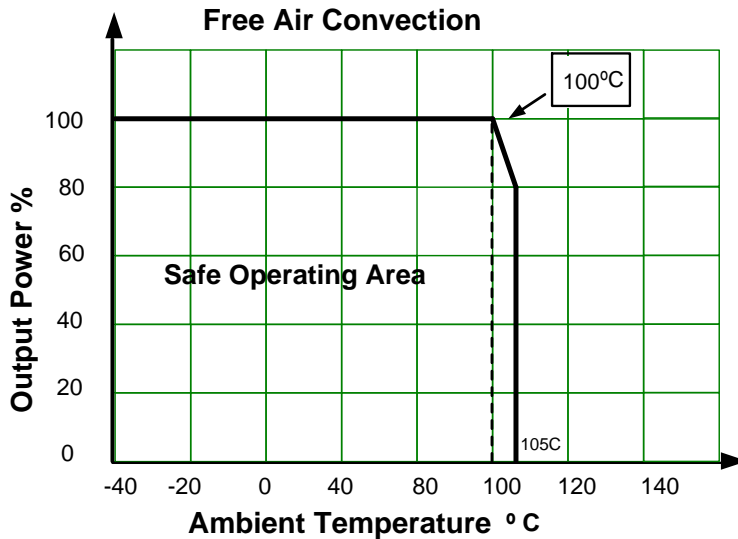

Load Accuracy Tolerance Graph

AM1LO-0503SH421

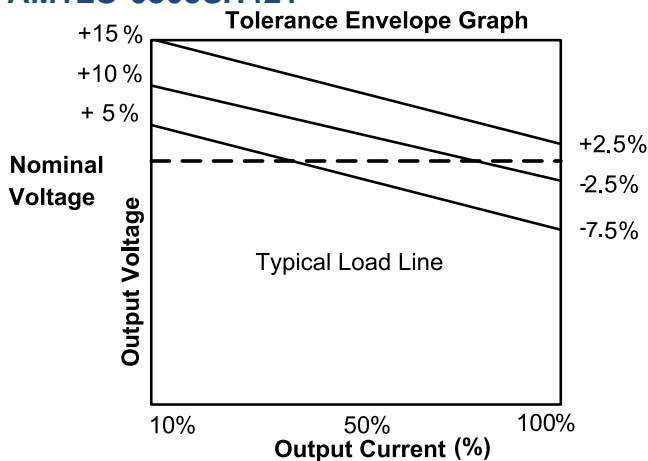

AM1LO-0303SH421 & AM1LO-0505SH421

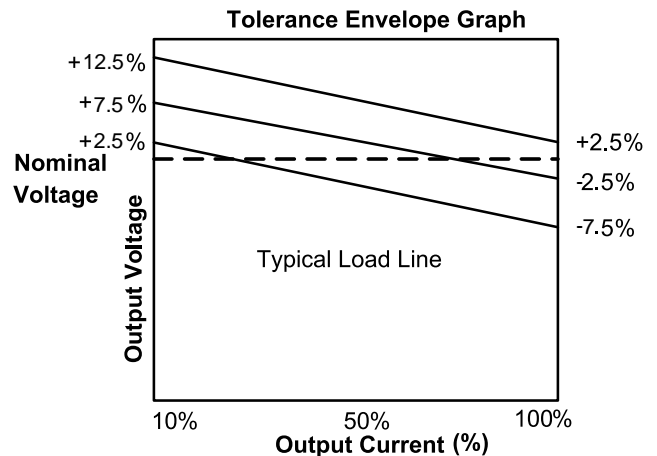

AM1LO-0305SH421

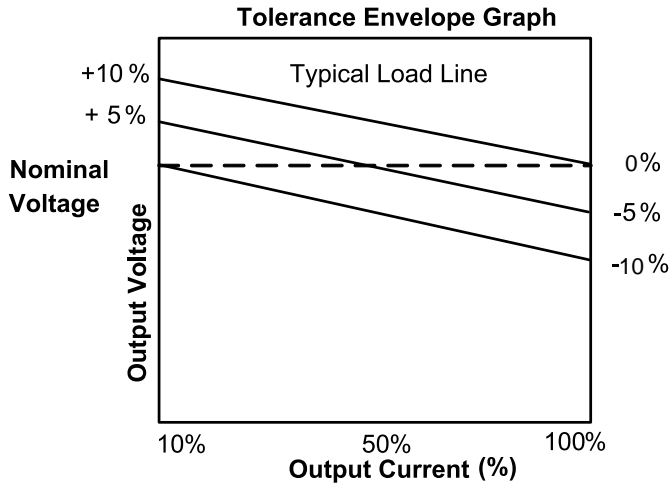

AM1LO-0303DH421

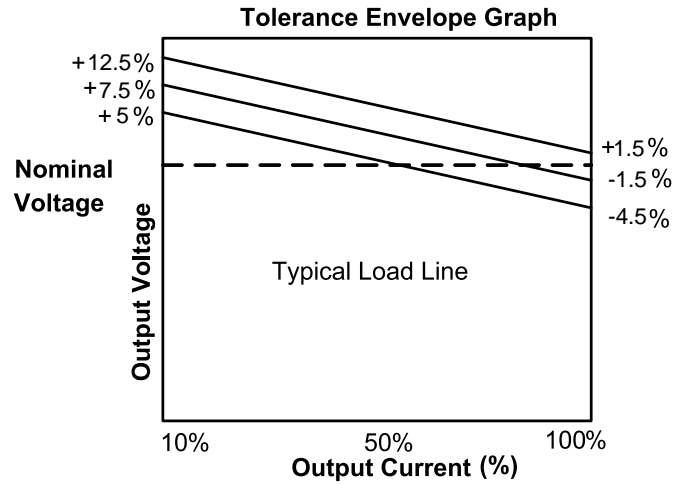

AM1LO-0305DH421 & AM1LO-0505DH421

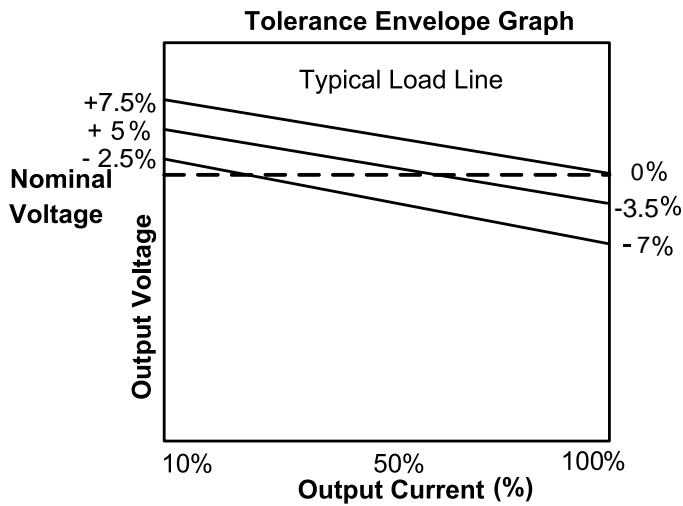

AM1LO-0503DH421

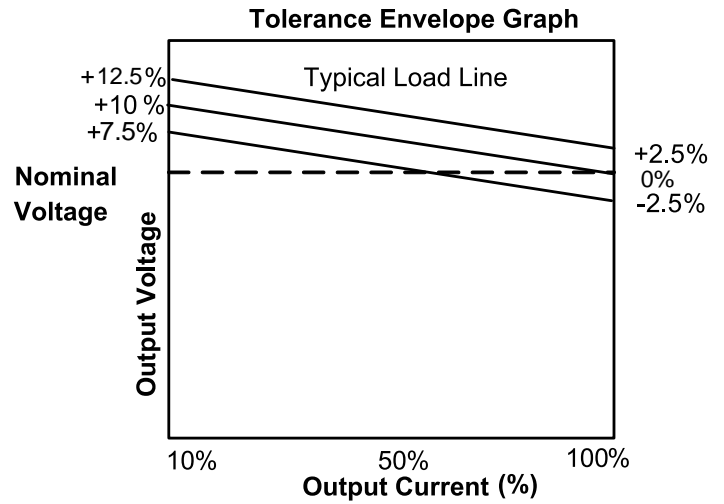

Typical Efficiency vs. Loading

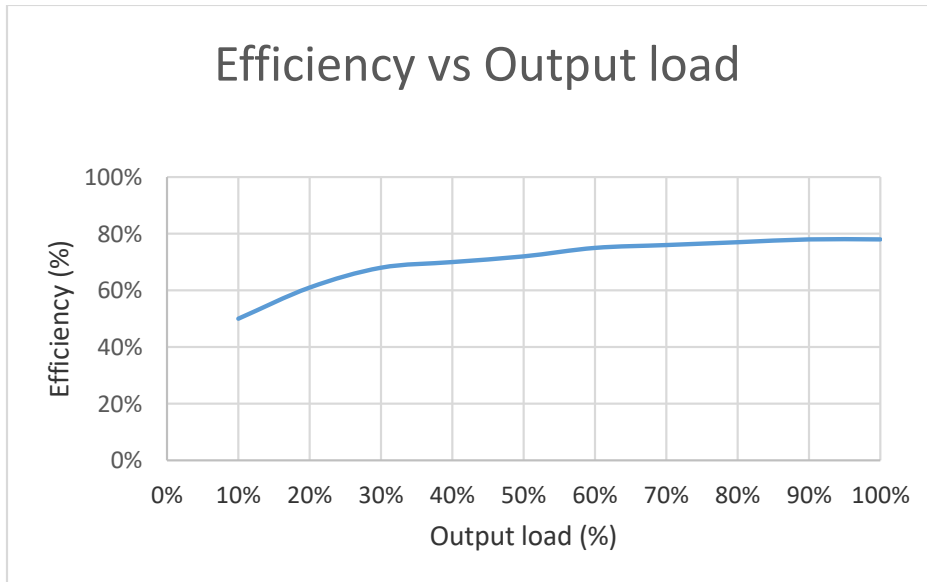

NOTE: **1.** Datasheets are updated as needed and as such, specifications are subject to change without notice. Once printed or downloaded, datasheets are no longer controlled by Aimtec; refer to www.aimtec.com for the most current product specifications. **2.** Product labels shown, including safety agency certifications on labels, may vary based on the date manufactured. **3.** Mechanical drawings and specifications are for reference only. **4.** All specifications are measured at an ambient temperature of 25°C, humidity<75%, nominal input voltage and at rated output load unless otherwise specified. **5.** Aimtec may not have conducted destructive testing or chemical analysis on all internal components and chemicals at the time of publishing this document. CAS numbers and other limited information are considered proprietary and may not be available for release. **6.** This product is not designed for use in critical life support systems, equipment used in hazardous environments, nuclear control systems or other such applications which necessitate specific safety and regulatory standards other the ones listed in this datasheet. **7.** Warranty is in accordance with Aimtec's standard Terms of Sale available at www.aimtec.com.