

Click to  
**ORDER**  
samples

AM200W-NZ

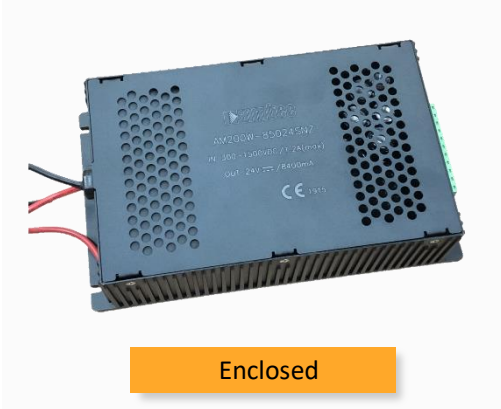

Enclosed

Aimtec's AM200W-NZ series is a 200W photovoltaic DC-DC converter. It provides an ultra-wide input voltage range of 300-1500VDC, high efficiency up to 87% and low no load power consumption for energy sensitive applications.

This series has input under-voltage protection, reverse input voltage protection, output short circuit, over-current and over-voltage protection to maintain the system's stability and avoid frequent restarts. These protections greatly reduce the probability of power supply failure while enhancing the safety performance of the modular power supply and the load under abnormal working conditions.

Offering an MTBF over 300,000h and an isolation voltage up to 4000VAC, these models can be widely used in photovoltaic power generation, energy storage BMS, high voltage inverters and other related applications.

Features

- Ultra-wide 300~1500VDC input voltage range.
- Operating Temp : -40 °C to +70 °C
- High I/O isolation voltage : 4000VAC
- Low ripple & noise: 200mV(p-p), typ.
- High reliability, Long lifespan:  $\geq 300\ 000$  hrs
- Input reverse polarity and under voltage protection, output short circuit, overcurrent and over voltage protection
- Meets 5000m altitude requirements

Summary

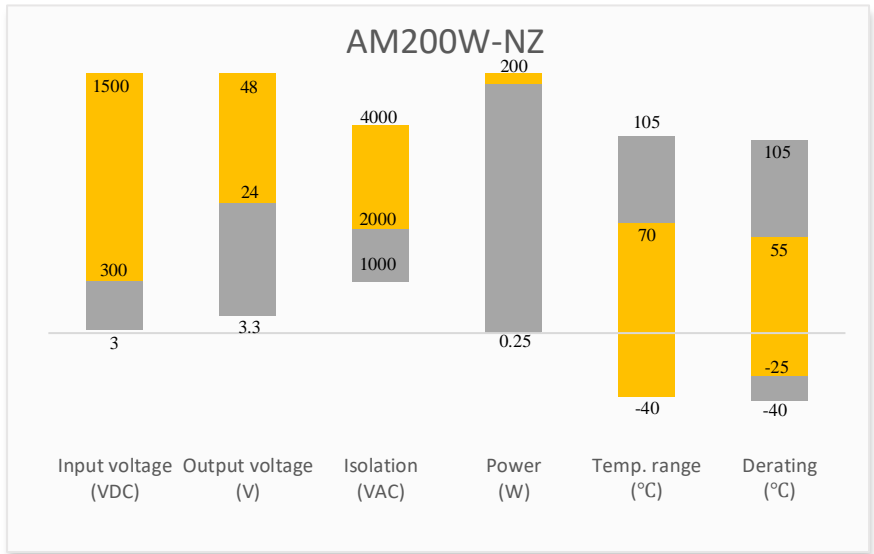

Training



Aimtec's AM200W-NZ  
200W Photovoltaic DC/DC Converter

Product Training Video  
(click to open)



Press Release

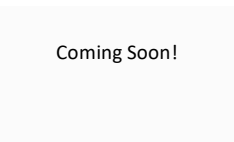

Coming Soon!

Application Notes

Applications



Renewable Energy

## Models & Specifications

Single Output					
Model	Input Voltage (VDC)	Output Voltage (VDC)	Output Current Max (A)	Maximum Capacitive Load ( $\mu$ F)	Efficiency (%) 850VDC / Full Load
AM200W-85024SNZ	850 (300 ~ 1500)	24	8.4	5000	86
AM200W-85048SNZ	850 (300 ~ 1500)	48	4.2	2000	87

Input Specification				
Parameters	Conditions	Typical	Maximum	Units
Voltage range	300 ~ 1500 VDC	850	1500	VDC
Input current	300 VDC		1200	mA
	850 VDC		450	
	1500 VDC		200	
Inrush current	850 VDC	150		A
	1500 VDC	250		
Input under-voltage protection	Under-voltage protection begins	265	285	VDC
	Under-voltage protection release	275	295	
External input fuse	15A/1500 VDC, Required			

Isolation Specification				
Parameters	Conditions	Typical	Maximum	Units
Tested voltage	Input / Output	Leakage current $\leq$ 10mA,1min	4000	VAC
	Input / Case	Leakage current $\leq$ 5mA,1min	2000	
	Output / Case	Leakage current $\leq$ 5mA,1min	2000	

Output Specification				
Parameters	Conditions	Typical	Maximum	Units
Voltage accuracy	0 ~ 100% load		$\pm$ 2	%
Line regulation	Full load		$\pm$ 1	%
Load regulation	0 ~ 100% load		$\pm$ 1	%
Short circuit protection	Hiccup, continuous, self-recovery			
Over current protection	hiccup, self-recovery	110 ~ 300		% of Iout
Over voltage protection	24V output model	$\leq$ 35VDC or hiccup protection		
	48V output model	$\leq$ 60VDC or hiccup protection		
Hold-up time	Full load, 25 °C	850 VDC input	5	ms
		1500 VDC input	8	
Start delay time*	300 ~ 1500 VDC		3	s
Temperature coefficient			$\pm$ 0.02	%/°C

Ripple & Noise	20MHz bandwidth	200	300	mV pk-pk
* Start-up delay time Test conditions: full voltage input range, full output load range(product input power-down to the input voltage re-power-on cooler time is greater than 15s.)				

General Specifications				
Parameters	Conditions	Typical	Maximum	Units
Switching frequency	Full load	65		KHz
Operating temperature		-40 to +70		°C
Storage temperature		-40 to +85		°C
Power derating	-40 ~ -25 °C	3.33		% / °C
	+55 ~ +70 °C	3.33		% / °C
	1400 ~ 1500 VDC	0.20		% / VDC
Cooling	Free air convection			
Humidity			95	% RH
Casing material	Metal			
Weight		1550		g
Dimensions (L x W x H)	8.47 x 4.92 x 1.97 inches, 215.00 x 125.00 x 50.00mm			
MTBF	≥ 300 000 hrs (MIL-HDBK -217F, t=+25°C)			

Safety Specifications		
Parameters		
Standards	Design to meet CSA-C22.2 No.107.1, EN62109	
	EMI - Conducted and radiated emission	CISPR32/EN55032 , Class A
	Electrostatic Discharge Immunity	IEC 61000-4-2 , Contact ± 6KV / Air ± 6KV , Criteria B
	RF, Electromagnetic Field Immunity	IEC 61000-4-3 , 10V/m , Criteria A
	Electrical Fast Transient/Burst Immunity	IEC 61000-4-4 , ± 2KV , Criteria B
	Surge Immunity	IEC 61000-4-5 , L- L ± 1KV / L- G ± 2KV , Criteria B
	CS, Conducted Disturbance Immunity	IEC 61000-4-6 , 10Vr.m.s , Criteria A

## Derating

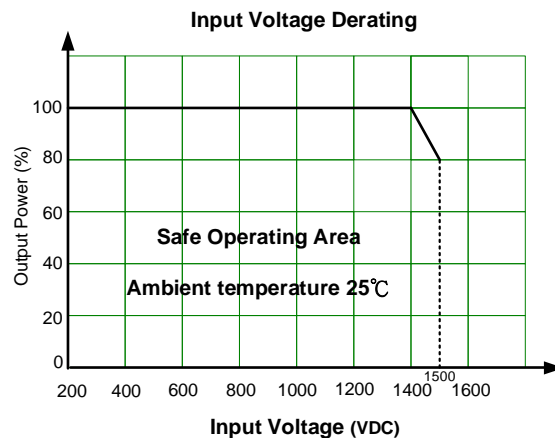
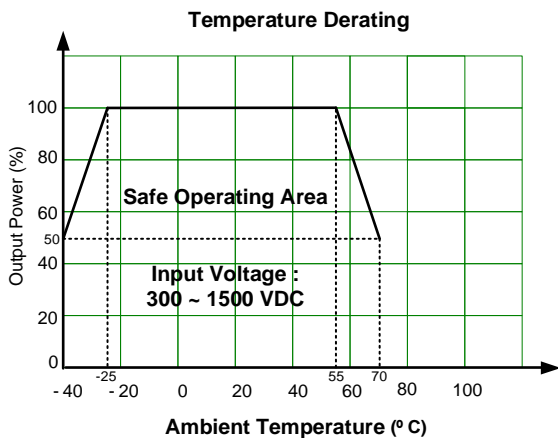

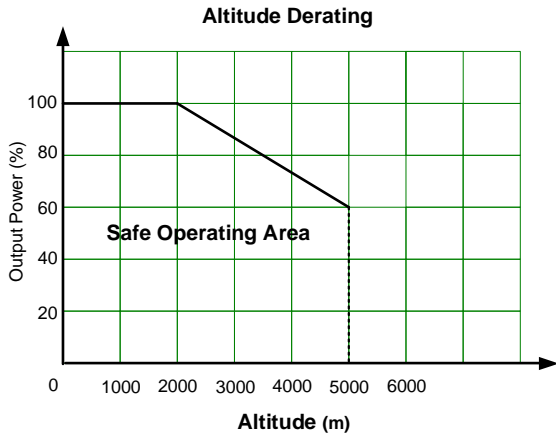

## Dimensions

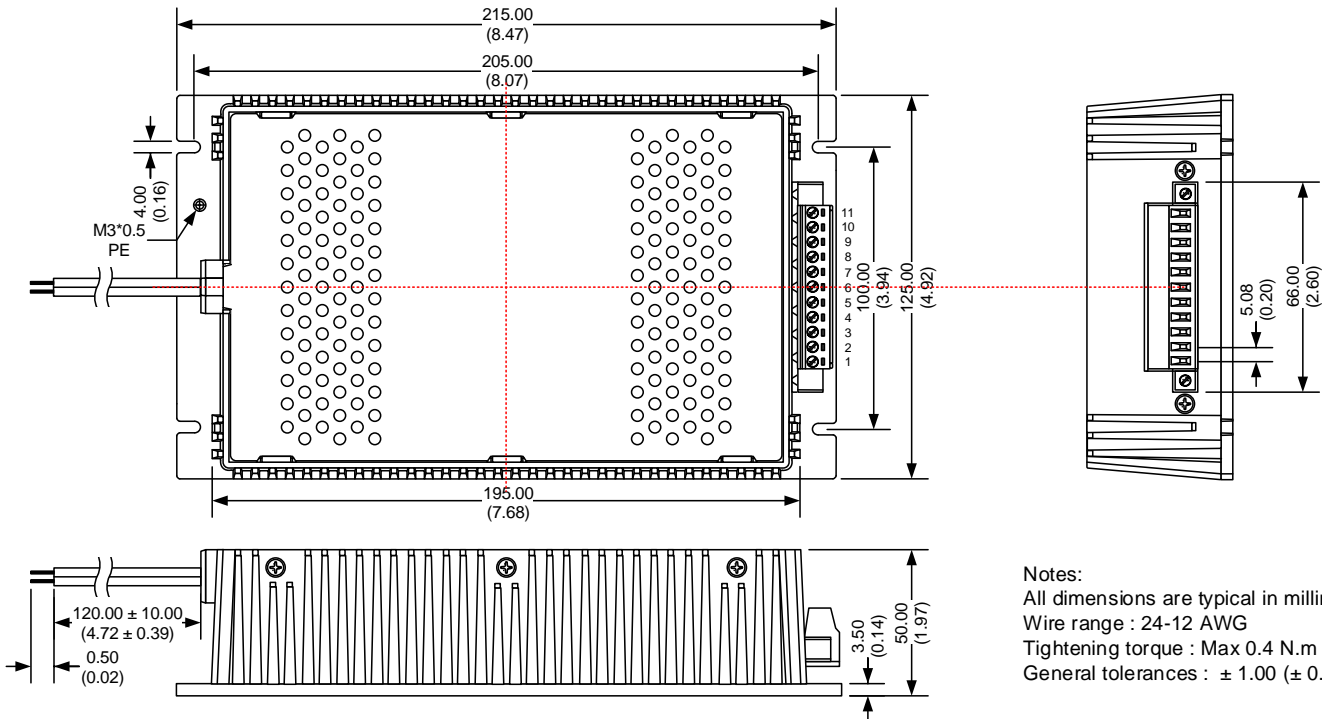

Notes:  
All dimensions are typical in millimeters (inches).  
Wire range : 24-12 AWG  
Tightening torque : Max 0.4 N.m  
General tolerances : ± 1.00 (± 0.04)

Pin Out Specifications			
Pin	Function	Pin	Function
1	-V Output	6	+V Output
2	-V Output	7	+V Output
3	-V Output	8	+V Output
4	-V Output	9	+V Output
5	N.C	10	Trim
		11	Trim
Red Wire (14AWG)	+V Input	Black Wire (14AWG)	-V Input

## Trimming



Output voltage can be externally trimmed by utilizing the methods as shown below

### Fixed Resistor

### Variable Potentiometer

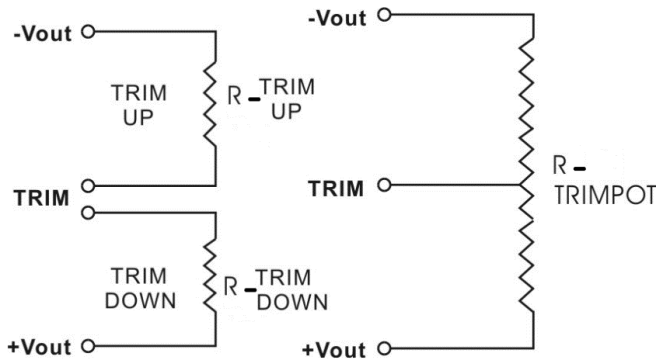

Leave open if not used.

### AM200W-85024SNZ

Trim down %	1	2	3	4	5	6	7	8	9	10
Vout (VDC)	23.76	23.52	23.28	23.04	22.8	22.56	22.32	22.08	21.84	21.6
Rt down (KΩ)	471.081	287.942	205.845	159.249	129.221	108.258	92.793	80.914	71.504	63.865
Trim up %	1	2	3	4	5	6	7	8	9	10
Vout (VDC)	24.24	24.48	24.72	24.96	25.2	25.44	25.68	25.92	26.16	26.4
Rt up (KΩ)	239.556	64.606	36.982	25.728	19.619	15.783	13.15	11.232	9.771	8.622

### AM200W-85048SNZ

Trim down %	1	2	3	4	5	6	7	8	9	10
Vout (VDC)	46.96	46.76	46.56	46.08	45.6	45.12	44.64	44.16	43.68	43.2
Rt down (KΩ)	19783.7	3281.617	1781.427	842.178	546.986	402.53	316.836	260.108	219.784	189.647
Trim up %	1	2	3	4	5	6	7	8	9	10
Vout (VDC)	48.48	48.96	49.44	49.92	50.4	50.88	51.36	51.84	52.32	52.8
Rt up (KΩ)	29.068	21.704	17.238	14.24	12.088	10.469	9.206	8.194	7.365	6.672

**NOTE:** **1.** Datasheets are updated as needed and as such, specifications are subject to change without notice. Once printed or downloaded, datasheets are no longer controlled by Aimtec; refer to [www.aimtec.com](http://www.aimtec.com) for the most current product specifications. **2.** Product labels shown, including safety agency certifications on labels, may vary based on the date manufactured. **3.** Mechanical drawings and specifications are for reference only. **4.** All specifications are measured at an ambient temperature of 25°C, humidity<75%, nominal input voltage and at rated output load unless otherwise specified. **5.** Aimtec may not have conducted destructive testing or chemical analysis on all internal components and chemicals at the time of publishing this document. CAS numbers and other limited information are considered proprietary and may not be available for release. **6.** This product is not designed for use in critical life support systems, equipment used in hazardous environments, nuclear control systems or other such applications which necessitate specific safety and regulatory standards other the ones listed in this datasheet. **7.** Warranty is in accordance with Aimtec's standard Terms of Sale available at [www.aimtec.com](http://www.aimtec.com).