



AM60-NZ



The AM60-NZ series is designed to offer an ultra-thin solution to customers with designs that have challenging height considerations. This series is available in both SIP and DIP packages with open frame and metal case options. The total height of 0.24inches (6.1mm) for the Dual Inline Package offers significant space optimization when compared to typical 6W DIP products with approximately twice the height (~0.4inches).

In addition, the AM60-NZ offers an impressive 500VAC isolation with a 2:1 input voltage range of 9-18 or 18-36VDC. It is also designed with input under-voltage protection, output over-voltage, over-current, short circuit protection, which enables the AM60-NZ series to be used in a variety of application related to industrial control, instrumentation and communication equipment's.

Encapsulated

Features



- Wide 2:1 Input Range: 9-18 & 18-36VDC
- Operating Temp: -40 °C to +85 °C
- Low ripple & noise, up to 100mV(p-p) max
- Efficiency up to 86%
- Adjustable output voltage
- Output short circuit, over current protection, over voltage protection
- Regulated Output

Summary

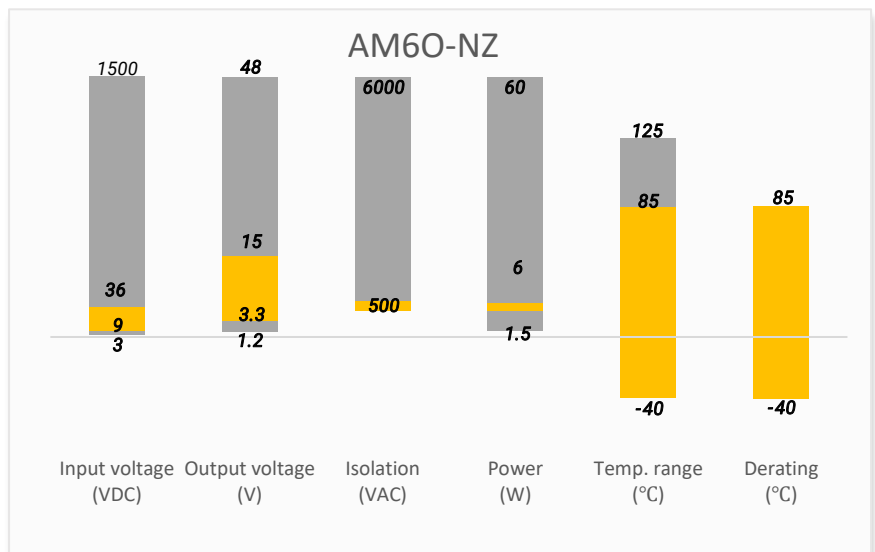

Training



Applications

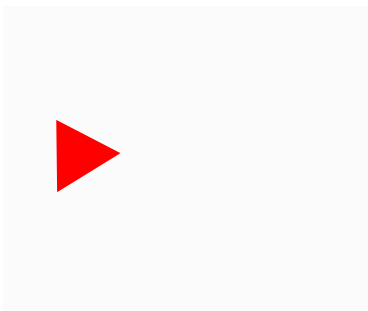

Product Training Video  
(click to open)

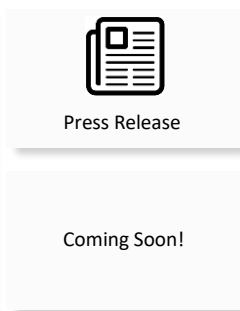

Application Notes



Power Grid



Industrial



Telecom



Instrumentation

## Models & Specifications

### Single Output

Model	Input Voltage (VDC)	Output Voltage (VDC)	Input Current Max (mA)		Output Current Max (mA)	Maximum Capacitive Load ( $\mu$ F)	Typ. Efficiency (%) Full Load
			No Load	Full Load			
AM60-1205SNZ	12 (9 ~ 18)	5	25	641	1200	1000	81
AM60-1212SNZ	12 (9 ~ 18)	12	30	610	500	680	85
AM60-1215SNZ	12 (9 ~ 18)	15	30	603	400	470	86
AM60-2403SNZ	24 (18 ~ 36)	3.3	15	272	1500	1800	79
AM60-2405SNZ	24 (18 ~ 36)	5	18	313	1200	1000	83
AM60-2412SNZ	24 (18 ~ 36)	12	20	302	500	680	85
AM60-2415SNZ	24 (18 ~ 36)	15	20	298	400	470	86

The standard part number is for DIP and open-frame package;

With adding suffix "-M" for DIP package with metal case (E.g. AM60-1205SNZ-M is for 5V model with DIP pin type and metal case);

With adding suffix "-L" for SMD and open-frame package (E.g. AM60-1205SNZ-L is for 5V model with SMD pin type and open frame);

With adding suffix "-LM" for SMD package with metal case (E.g. AM60-1205SNZ-LM is for 5V model with SMD pin type and metal case).

### Input Specification

Parameters	Conditions	Typical	Maximum	Units
Voltage range	See models table			VDC
Filter	Pi filter			
Absolute maximum rating	1 sec.	12VDC input models	25	VDC
		24VDC input models	50	VDC
Reflected ripple current		20		mA pk-pk
Start-up voltage	Nominal 12V input models		9	VDC
	Nominal 24V input models		18	
Input under voltage lockout	Nominal 12V input models	6.5		VDC
	Nominal 24V input models	15		
On/Off Control *	ON – 0 to 0.3Vdc, pulled low to GND or open; OFF – 2~12Vdc or pulled high, idle current 5mA typ.			

\* The Ctrl pin voltage is referenced to input GND.

### Isolation Specification

Parameters	Conditions	Typical	Maximum	Units
Tested I/O voltage	60 sec, 5mA max	500		VAC
Tested case to I/O voltage	60 sec, 5mA max, for metal case models	500		VAC
Resistance	500Vdc	$\geq 100$		M $\Omega$
Capacitance	I/O capacitance at 100KHz/0.1V	1000		pF

Output Specification					
Parameters	Conditions	Typical	Maximum	Units	
Voltage accuracy		± 1	± 3	%	
Line regulation	Full load	± 0.2	± 0.5	%	
Load regulation	5 ~ 100% load	± 0.5	± 1	%	
Over voltage protection			160	% Vout	
Over current protection		140	200	% Iout	
Short circuit protection	Continuous, Auto recovery				
Temperature coefficient	Full load		± 0.03	%/°C	
Ripple & Noise*	20MHz bandwidth, 5 ~ 100% load	50	100	mV pk-pk	
Transient recovery time	25% load step change	300	500	µS	
Transient response deviation	25% load step change	Output 3.3VDC / 5VDC	±5	±8	%
		Others	±3	±5	

\* Ripple and Noise are measured at 20MHz bandwidth by using a 1µF (M/C) and 10µF (E/C) parallel capacitor and typical input with full load

General Specifications				
Parameters	Conditions	Typical	Maximum	Units
Switching frequency	100% load	330		KHz
Operating temperature	Without derating	-40 to +85		°C
Storage temperature		-55 to +125		°C
Reflow soldering temperature	Peak temp ≤ 245°C, 60 sec max at 217°C, please refer to IPC/JEDEC J-STD-020D.1.			
Soldering temperature	1.5mm from case 10 sec max		300	°C
Cooling	Free air convection (20 LFM)			
Humidity	Non-condensing		95	% RH
Case material	Aluminum alloy			
Vibration	10-55Hz, 10G, 30min. along X,Y and Z			
Weight	Open-frame models	4.7		g
	Metal case models	5.7		
Dimensions (L x W x H)	Standard DIP and open-frame package	1.24 x 0.71 x 0.24 inches, 31.60 x 18.10 x 6.10mm		
	Optional SMD and open-frame package	1.33 x 0.71 x 0.25 inches, 33.78 x 18.10 x 6.30mm		
	Optional DIP package with metal case	1.28 x 0.75 x 0.27 inches, 32.60 x 19.10 x 6.80mm		
	Optional SMD package with metal case	1.33 x 0.75 x 0.28 inches, 33.78 x 19.10 x 7.00mm		
MTBF	> 1 000 000 hrs (MIL-HDBK -217F, t=+25°C) / Full Load			

Safety Specifications		
Parameters		
Standards	Designed to meet UL/IEC/EN 62368	
	EMC - Conducted and radiated emission	EN55032, CLASS A EN55032, CLASS B with recommended circuit
	Electrostatic Discharge Immunity	IEC 61000-4-2, Criteria B
	RF, Electromagnetic Field Immunity	IEC 61000-4-3, Criteria A
	Electrical Fast Transient/Burst Immunity	IEC 61000-4-4, Criteria B with recommended circuit
	Surge Immunity	IEC 61000-4-5, Criteria B with recommended circuit
	RF, Conducted Disturbance Immunity	IEC 61000-4-6, Criteria A

Note: The case grounding connection to the ground is strongly suggested for the EMC consideration (For the models with optional "-M" only)

Derating

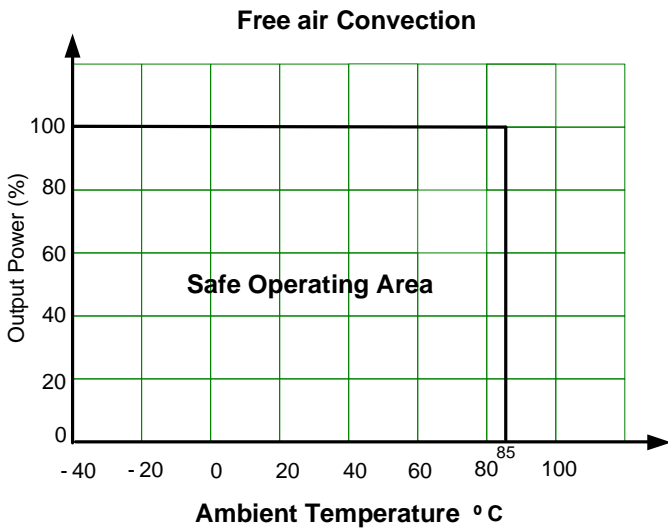

Typical Application Circuit

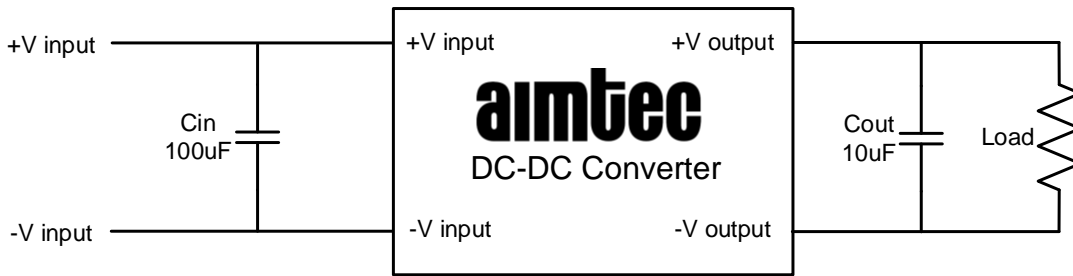

EMC Recommended Circuit

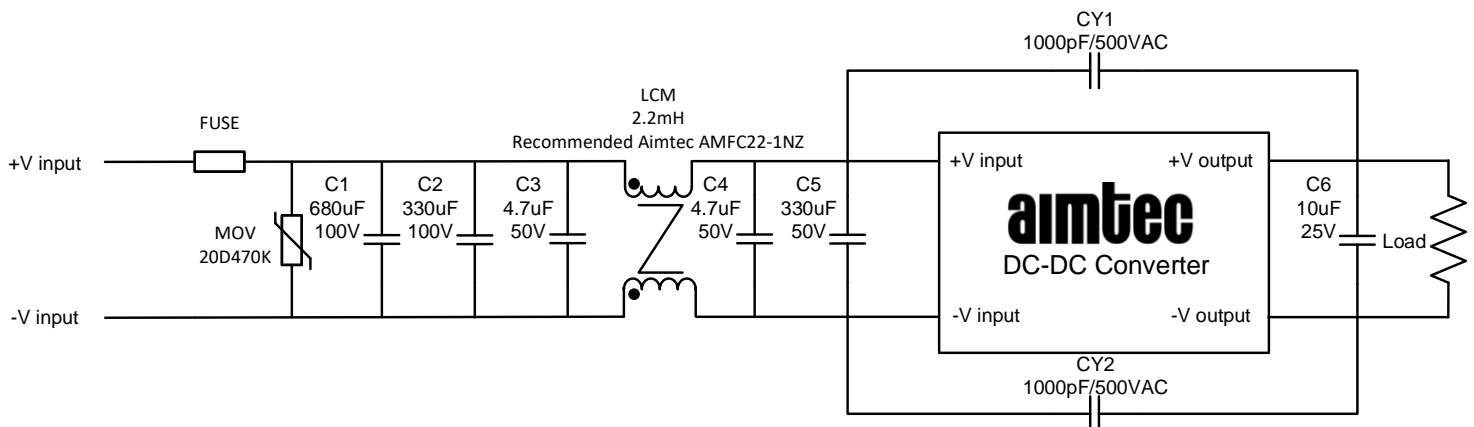

Fuse : Choose according to actual input current.

Dimensions

Standard DIP and open-frame package models

Front View

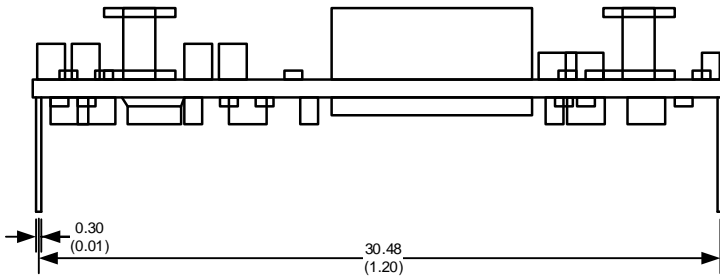

Right View

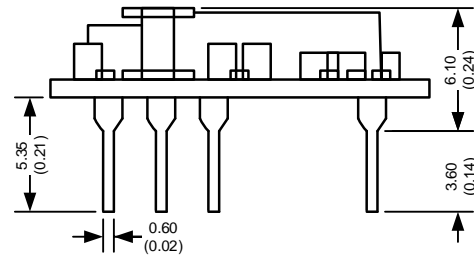

Bottom View

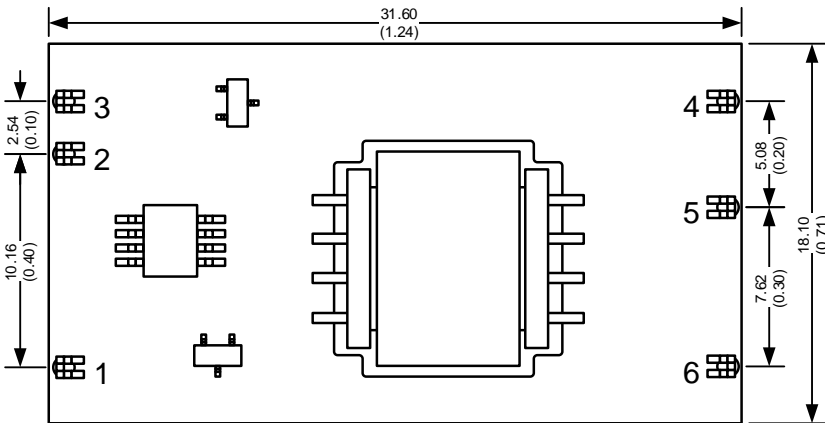

Notes:

All dimensions are typical in millimeters (inches).  
Pin section tolerance :  $\pm 0.1$  ( $\pm 0.004$ )  
Stand-off tolerance  $\pm 0.50$  ( $\pm 0.02$ )

$\varnothing 1.10$  [ $\varnothing 0.043$ ]

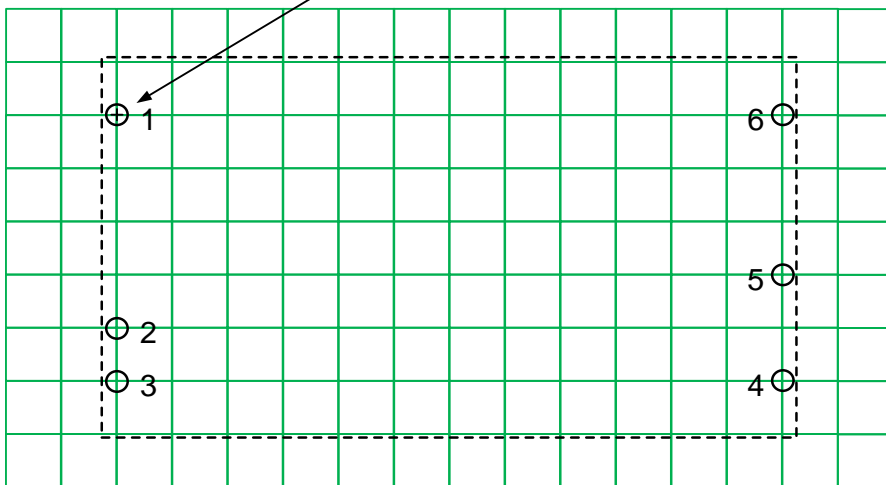

Note : Grid 2.54\*2.54 mm

Pin Out Specifications	
Pin	Single
1	+V Input
2	Ctrl
3	-V Input
4	-V Output
5	Trim
6	+V Output

### Optional DIP package with metal case models

Front View

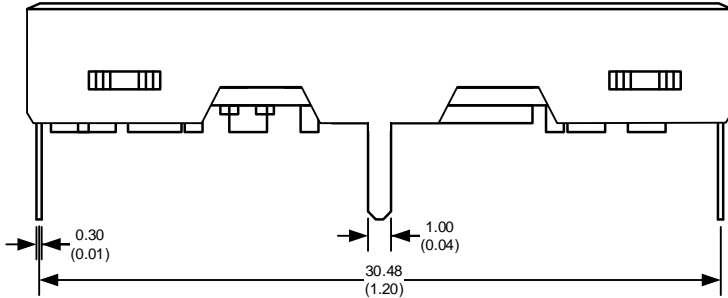

Right View

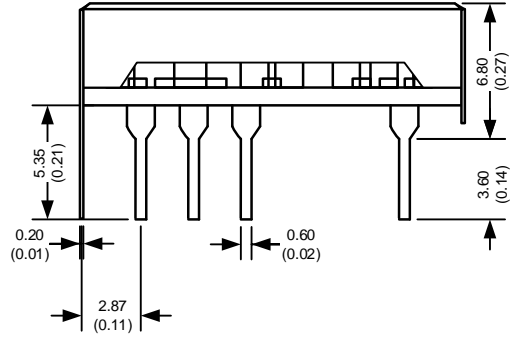

Bottom View

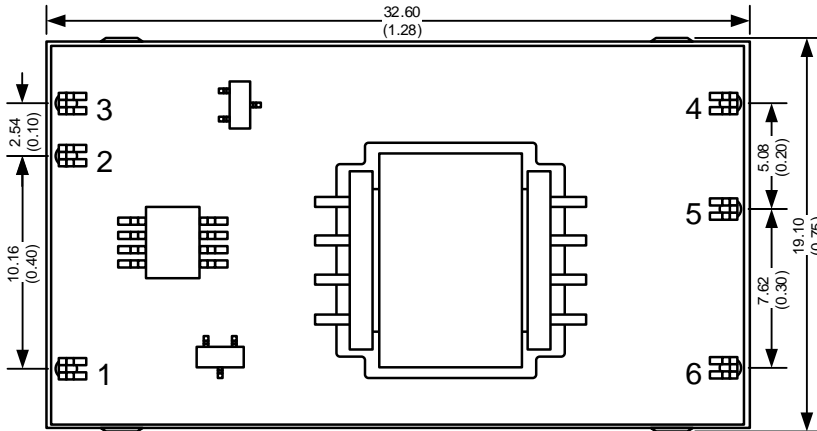

Notes:

All dimensions are typical in millimeters (inches).

Pin section tolerance :  $\pm 0.1$  ( $\pm 0.004$ )

Stand-off tolerance  $\pm 0.50$  ( $\pm 0.02$ )

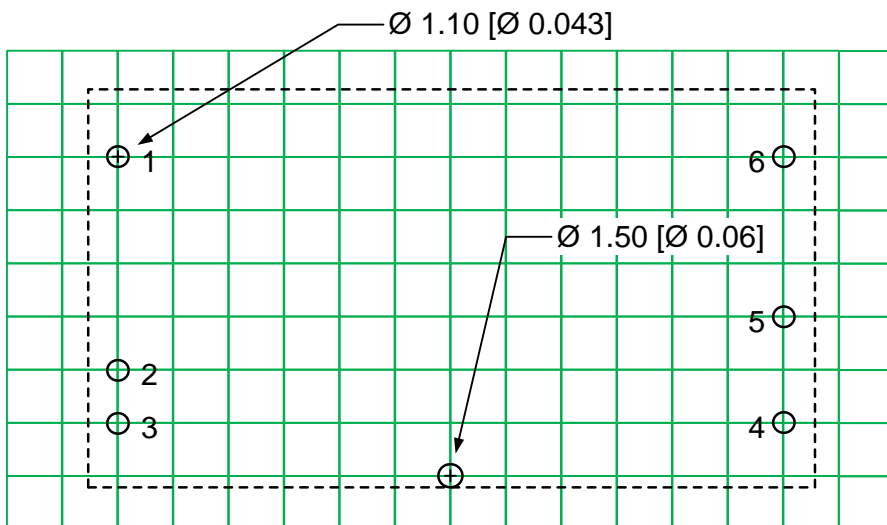

Note : Grid 2.54\*2.54 mm

Pin Out Specifications	
Pin	Single
1	-V Input
2	Trim
3	NC
4	+V Output
5	-V Output
6	+V Input

## Optional SMD and open-frame package models

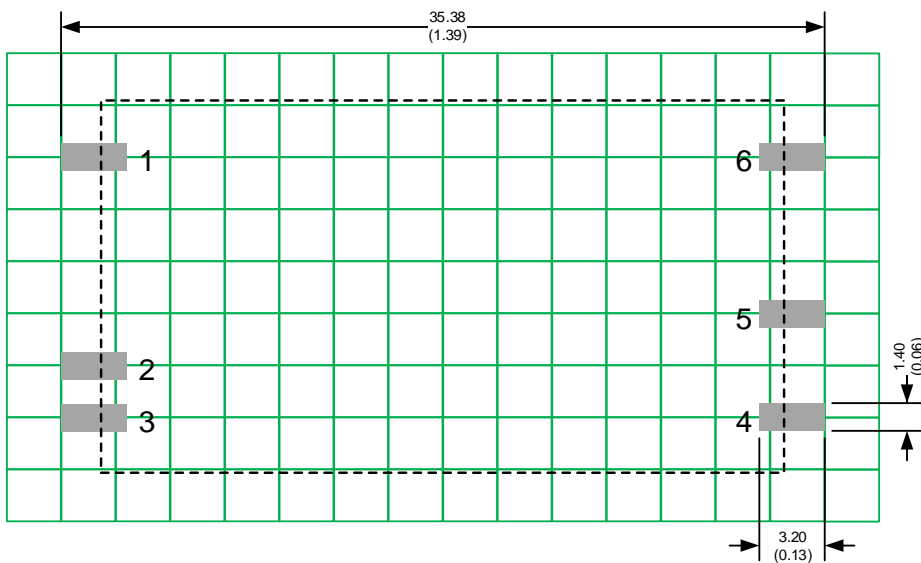
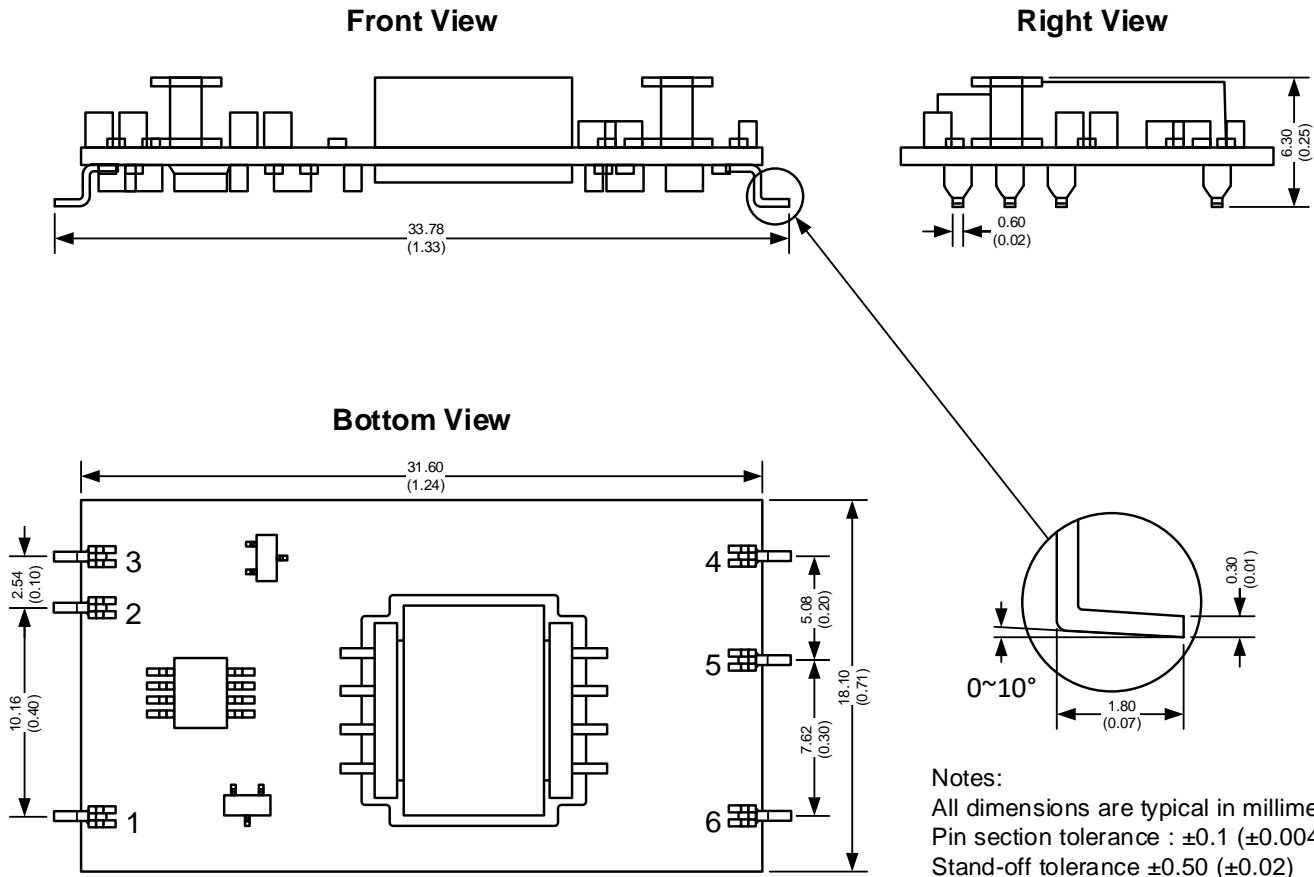

Note : Grid 2.54\*2.54 mm

Pin Out Specifications	
Pin	Single
1	+V Input
2	Ctrl
3	-V Input
4	-V Output
5	Trim
6	+V Output

### Optional SMD package with metal case models

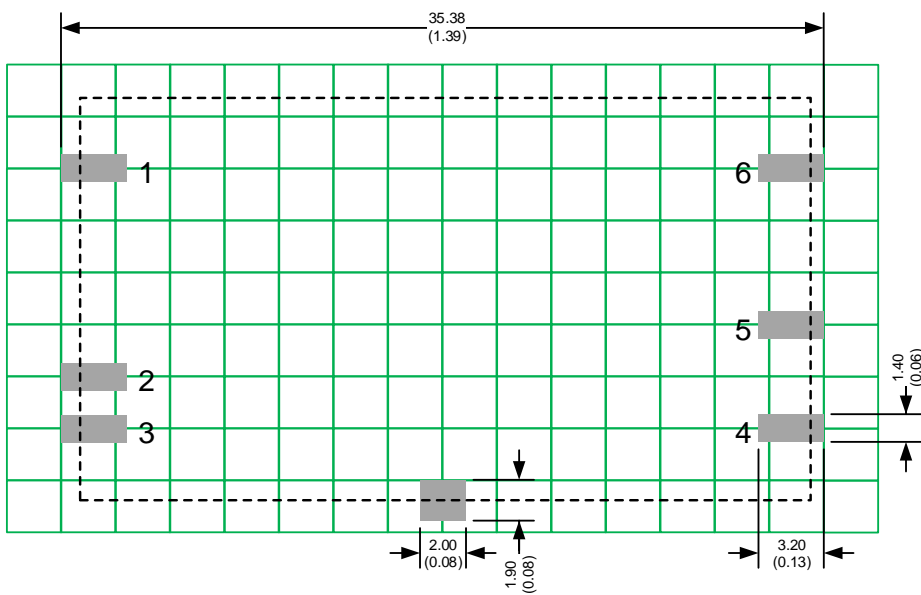
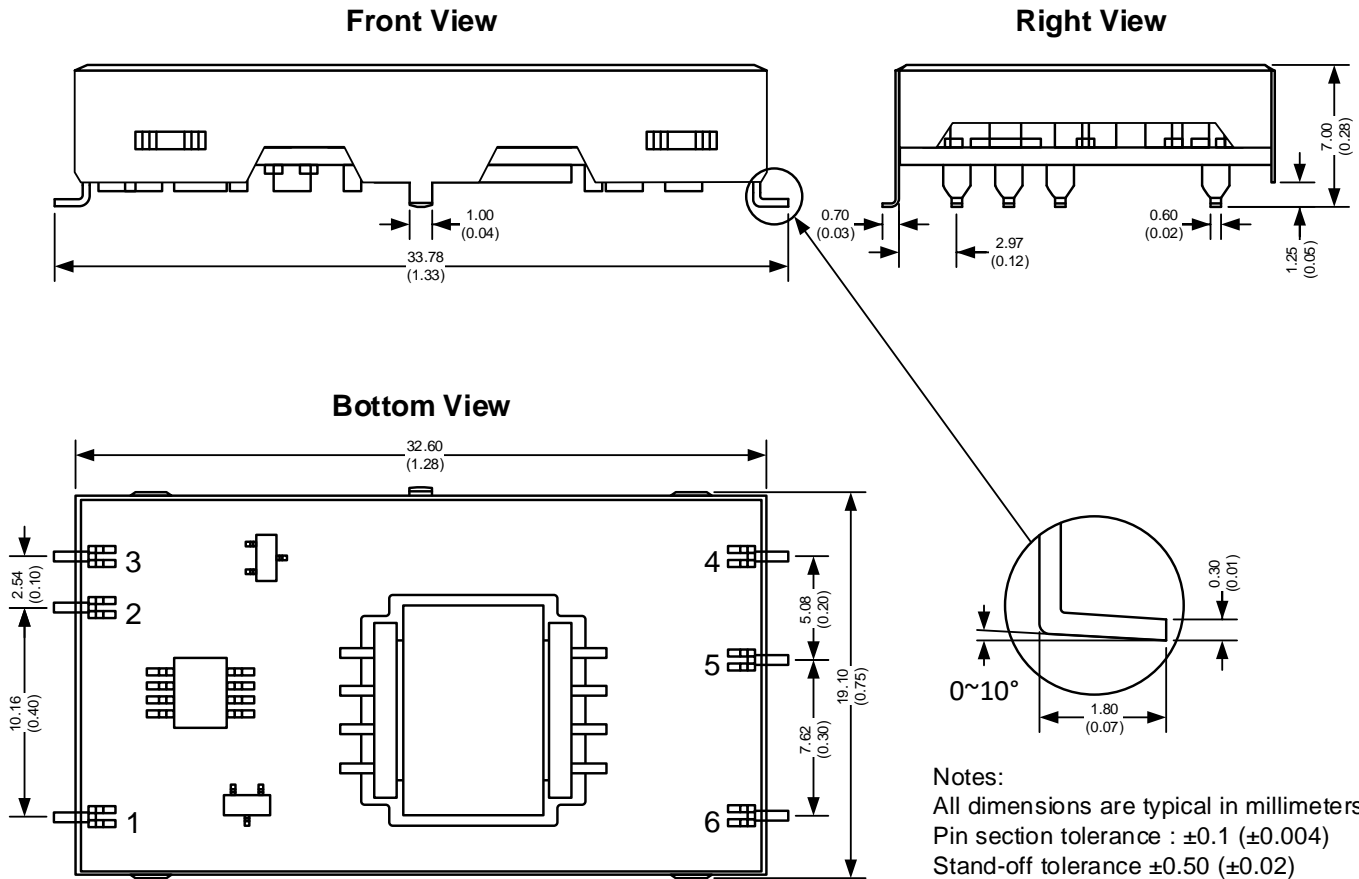

Note : Grid 2.54\*2.54 mm

Pin Out Specifications	
Pin	Single
1	+V Input
2	Ctrl
3	-V Input
4	-V Output
5	Trim
6	+V Output



## Trimming



Output voltage can be externally trimmed by utilizing the methods as shown below

### Fixed Resistor

### Variable Potentiometer

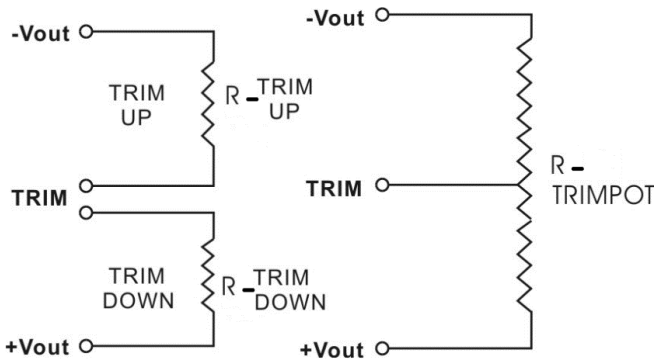

Leave open if not used.

### AM60-1205SNZ(-M/-L/-LM)

Trim down %	1	2	3	4	5	6	7	8	9	10
Vout (VDC)	4.950	4.900	4.850	4.800	4.750	4.700	4.650	4.600	4.550	4.500
Rt down (KΩ)	54.906	33.833	22.748	15.910	11.272	7.918	5.380	3.393	1.795	0.482
Trim up %	1	2	3	4	5	6	7	8	9	10
Vout (VDC)	5.062	5.100	5.150	5.200	5.250	5.300	5.350	5.400	5.450	5.500
Rt up (KΩ)	7165.000	178.344	72.562	42.868	28.884	20.750	15.430	11.680	8.893	6.742

### AM60-1212SNZ(-M/-L/-LM)

Trim down %	1	2	3	4	5	6	7	8	9	10
Vout (VDC)	11.880	11.760	11.640	11.520	11.400	11.280	11.160	11.040	10.920	10.800
Rt down (KΩ)	478.092	283.452	194.527	143.585	110.573	87.442	70.332	57.164	46.716	38.223
Trim up %	1	2	3	4	5	6	7	8	9	10
Vout (VDC)	12.120	12.240	12.360	12.480	12.600	12.720	12.840	12.865	12.890	12.915
Rt up (KΩ)	688.435	140.920	65.879	36.075	20.077	10.095	3.274	2.116	1.030	0.009

### AM60-1215SNZ(-M/-L/-LM)

Trim down %	1	2	3	4	5	6	7	8	9	10
Vout (VDC)	14.850	14.700	14.550	14.400	14.250	14.100	13.950	13.800	13.650	13.500
Rt down (KΩ)	623.045	395.763	285.907	221.156	178.462	148.196	125.620	108.134	94.191	82.813
Trim up %	1	2	3	4	5	6	7	8	9	10
Vout (VDC)	15.150	15.300	15.450	15.600	15.750	15.900	16.050	16.200	16.350	16.500
Rt up (KΩ)	1859.550	199.069	98.516	62.236	43.530	32.118	24.431	18.899	14.729	11.473

### AM60-2403SNZ(-M/-L/-LM)

Trim down %	1	2	3	4	5	6	7	8	9	10
Vout (VDC)	3.267	3.234	3.201	3.168	3.135	3.102	3.069	3.036	3.003	2.970
Rt down (KΩ)	119.557	77.342	55.087	41.342	32.009	25.259	20.148	16.145	12.925	10.278
Trim up %	1	2	3	4	5	6	7	8	9	10
Vout (VDC)	3.342	3.366	3.399	3.432	3.465	3.498	3.531	3.564	3.597	3.630
Rt up (KΩ)	4250.376	224.149	90.726	53.640	36.229	26.118	19.511	14.857	11.400	8.732

### AM60-2405SNZ(-M/-L/-LM)

Trim down %	1	2	3	4	5	6	7	8	9	10
Vout (VDC)	4.950	4.900	4.850	4.800	4.750	4.700	4.650	4.647	4.644	4.642
Rt down (KΩ)	49.906	28.833	17.748	10.910	6.272	2.918	0.380	0.248	0.117	0.031
Trim up %	1	2	3	4	5	6	7	8	9	10
Vout (VDC)	5.062	5.100	5.150	5.200	5.250	5.300	5.350	5.400	5.450	5.500
Rt up (KΩ)	7160.000	173.344	67.562	37.868	23.884	15.750	10.430	6.680	3.893	1.742

### AM60-2412SNZ(-M/-L/-LM)

Trim down %	1	2	3	4	5	6	7	8	9	10
Vout (VDC)	11.880	11.760	11.640	11.520	11.400	11.280	11.160	11.040	10.920	10.800
Rt down (KΩ)	478.092	283.452	194.527	143.585	110.573	87.442	70.332	57.164	46.716	38.223
Trim up %	1	2	3	4	5	6	7	8	9	10
Vout (VDC)	12.120	12.240	12.360	12.480	12.600	12.720	12.840	12.865	12.890	12.915
Rt up (KΩ)	688.435	140.920	65.879	36.075	20.077	10.095	3.274	2.116	1.030	0.009

### AM60-2415SNZ(-M/-L/-LM)

Trim down %	1	2	3	4	5	6	7	8	9	10
Vout (VDC)	14.850	14.700	14.550	14.400	14.250	14.100	13.950	13.800	13.650	13.500
Rt down (KΩ)	623.045	395.763	285.907	221.156	178.462	148.196	125.620	108.134	94.191	82.813
Trim up %	1	2	3	4	5	6	7	8	9	10
Vout (VDC)	15.150	15.300	15.450	15.600	15.750	15.900	16.050	16.200	16.350	16.500
Rt up (KΩ)	1859.550	199.069	98.516	62.236	43.530	32.118	24.431	18.899	14.729	11.473

**NOTE:** **1.** Datasheets are updated as needed and as such, specifications are subject to change without notice. Once printed or downloaded, datasheets are no longer controlled by Aimtec; refer to [www.aimtec.com](http://www.aimtec.com) for the most current product specifications. **2.** Product labels shown, including safety agency certifications on labels, may vary based on the date manufactured. **3.** Mechanical drawings and specifications are for reference only. **4.** All specifications are measured at an ambient temperature of 25°C, humidity<75%, nominal input voltage and at rated output load unless otherwise specified. **5.** Aimtec may not have conducted destructive testing or chemical analysis on all internal components and chemicals at the time of publishing this document. CAS numbers and other limited information are considered proprietary and may not be available for release. **6.** This product is not designed for use in critical life support systems, equipment used in hazardous environments, nuclear control systems or other such applications which necessitate specific safety and regulatory standards other the ones listed in this datasheet. **7.** Warranty is in accordance with Aimtec's standard Terms of Sale available at [www.aimtec.com](http://www.aimtec.com).