

FEATURES:

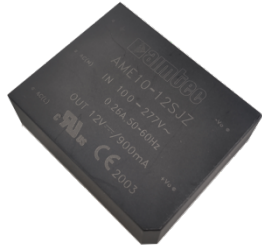

- I/O Isolation 3000VAC
- Operating Temp: -40°C to +70°C
- Over current Protection
- Input: 85-305VAC, 47-63Hz, or 100-430VDC
- Low Ripple and Noise
- Over Voltage Protection
- Up to 82% efficiency
- Short Circuit Protection



Models Single output

Model	Input Voltage (VAC/Hz)	Input Voltage (VDC)	Max Output wattage (W)	Output Voltage (V)	Output Current max (A)	Maximum capacitive load (μF)	Efficiency (%)
							230 VAC
AME10-3.3SJZ	85-305/47-63	100-430	6.6	3.3	2	26000	70
AME10-5SJZ	85-305/47-63	100-430	10	5	2	9400	76
AME10-9SJZ	85-305/47-63	100-430	10	9	1.1	3600	78
AME10-12SJZ	85-305/47-63	100-430	10	12	0.9	2400	80
AME10-15SJZ	85-305/47-63	100-430	10	15	0.7	1200	81
AME10-24SJZ	85-305/47-63	100-430	10	24	0.45	370	82

Note:

*Add suffix “-ST” for optional screw terminal bottom plate, add suffix “-STD” for optional DIN Rail screw terminal bottom plate

Input Specifications

Parameters	Conditions	Typical	Maximum	Units
Current (full load)	115 VAC		260	mA
	230 VAC		160	mA
Inrush current <2ms (cold start)	115 VAC	10		A
	230 VAC	15		A
Leakage current			0.25	mA
External fuse	Recommended slow blow type	2		A

Output Specifications

Parameters	Conditions	Typical	Maximum	Units
Voltage accuracy		±2		%
Line regulation	(LL-HL)	±0.5		%
Load regulation	10-100% load	±1		%
Ripple & Noise			100	mV p-p
Hold-up time	115 VAC	15		ms
	230 VAC	80		ms

Isolation Specifications

Parameters	Conditions	Typical	Rated	Units
Tested I/O voltage	Input to Output, 60 sec		3000	VAC
	Input to Ground		2000	
Isolation resistance		>1000		MΩ

General Specifications

Parameters	Conditions	Typical	Maximum	Units
Switching frequency		100		KHz
Over current protection		≥110		% of Iout
Over voltage protection		Zener Diode Clamp		
Short circuit protection		Auto recovery		
Operating temperature	See derating curve	-40 to +70		°C

Maximum case temperature		100	°C
Storage temperature		-40 to +105	°C
Temperature coefficient		±0.02	% / °C

General Specifications (continued)

Parameters	Conditions	Typical	Maximum	Units
Cooling		Free air convection		
Humidity	Non condensing		95	% RH
Case material		Plastic (flammability to UL 94V-0)		
Weight	Pin mountable	75		g
	Screw terminal bottom plate	125		
	DIN Rail screw terminal bottom plate	165		
Dimensions (L x W x H)	Pin mountable	55.0 x 45.0 x 21.0 mm (2.17 x 1.77 x 0.83 inches)		
	Screw terminal bottom plate	96.1 x 54.0 x 29.5 mm (3.78 x 2.13 x 1.16 inches)		
	DIN Rail screw terminal bottom plate	96.1 x 54.0 x 34.1 mm (3.78 x 2.13 x 1.34 inches)		
MTBF		> 300 000 hrs (MIL-HDBK -217F, t _a =+25°C)/ Full Load		

NOTE: All specifications in this datasheet are measured at an ambient temperature of 25°C, humidity<75%, nominal input voltage (115/230VAC) and at rated output load unless otherwise specified.

Safety Specifications

Parameters		
Agency approvals	CE, UL	
Standards	Information Technology Equipment	IEC/EN/UL 60950-1
	EMI - Conducted and radiated emission	EN55022, class B EN55024: 2010
	Electrostatic Discharge Immunity	IEC 61000-4-2: Contact ±6KV/Air ±8KV, Criteria B
	RF, Electromagnetic Field Immunity	IEC 61000-4-3: 10V/m, Criteria A
	Electrical Fast Transient/Burst Immunity	IEC 61000-4-4: ±2KV, Criteria B
	Surge Immunity	IEC 61000-4-5: ±1KV/±2KV, Criteria B
	RF, Conducted Disturbance Immunity	IEC 61000-4-6: 10Vrms, Criteria A
	Power frequency Magnetic Field Immunity	IEC 61000-4-8: 10A/m, Criteria A
	Voltage dips, Short Interruptions Immunity	IEC 61000-4-11: 0-70%, Criteria B

Typical Application circuit

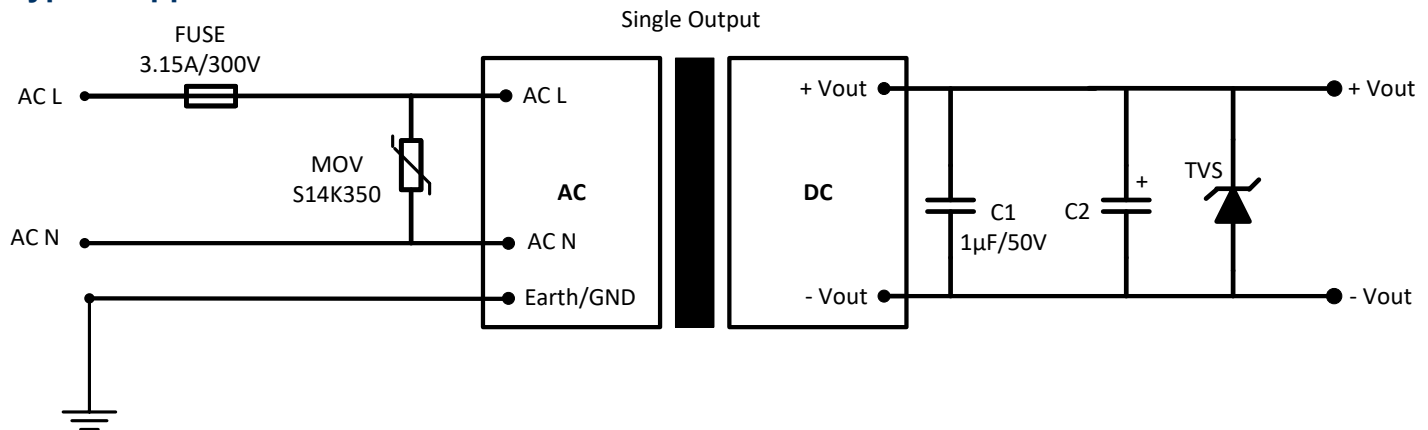

Vout	C2	TVS
3.3V	470 µF/50V	7A
5V	330 µF/50V	7A
9V	120 µF/50V	12A
12 & 15V	120 µF/50V	20A
24V	68 µF/50V	30A

Dimensions

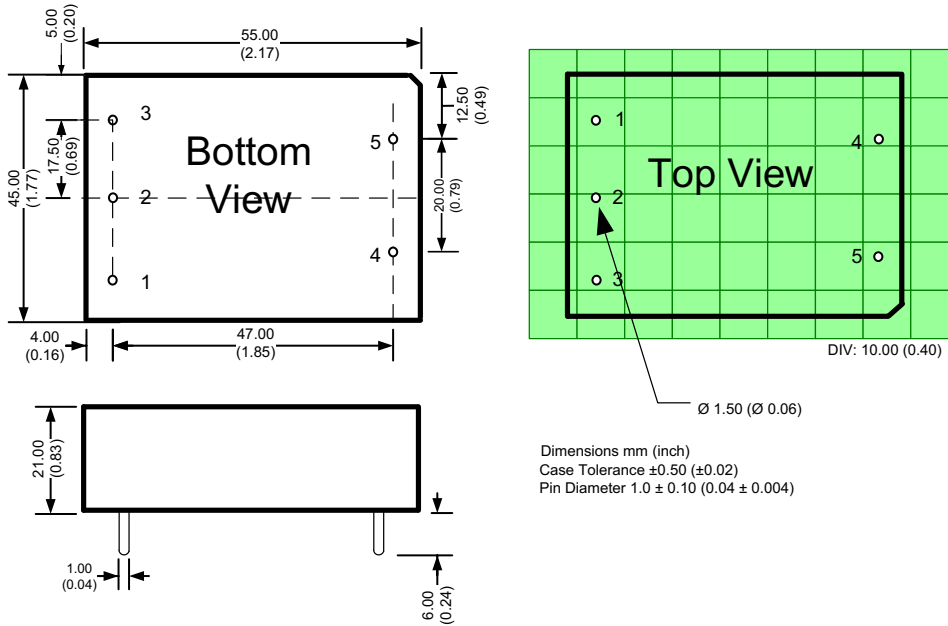

Pin Out Specifications

Pin	Single
1	Earth/Ground
2	AC Input (N)
3	AC Input (L)
4	- V output
5	+ V output

Dimensions with optional ST model

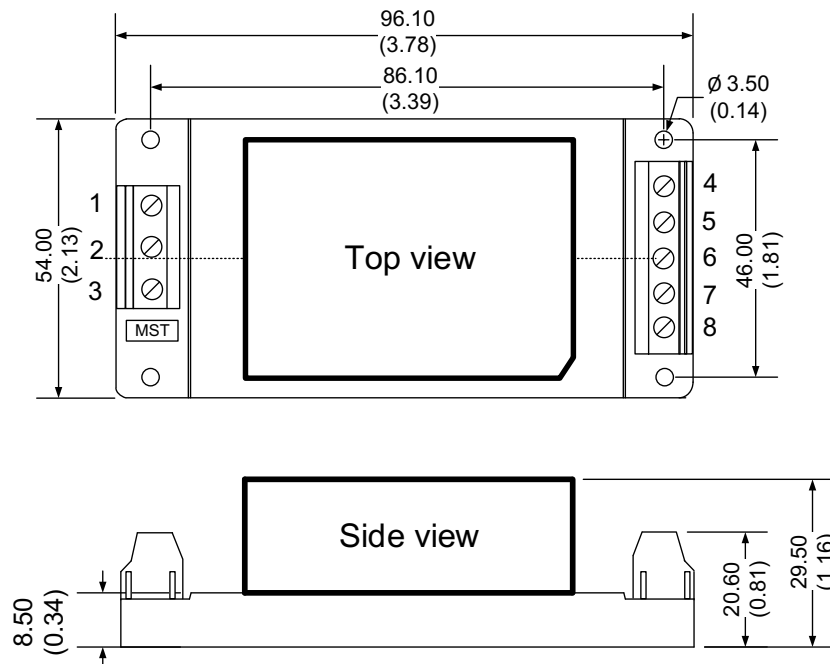

Pin Out Specifications

Pin	Single
1	Earth/Ground
2	AC Input (N)
3	AC Input (L)
4	- V output
5	No Connection
6	No Connection
7	No Connection
8	+ V output

Dimensions: mm (inch)
 Case Tolerance: ± 1.00 (0.04)
 Holding holes tolerance: ± 0.20 (0.01)
 Wire gauge: 24-12AWG

Dimensions with optional STD model

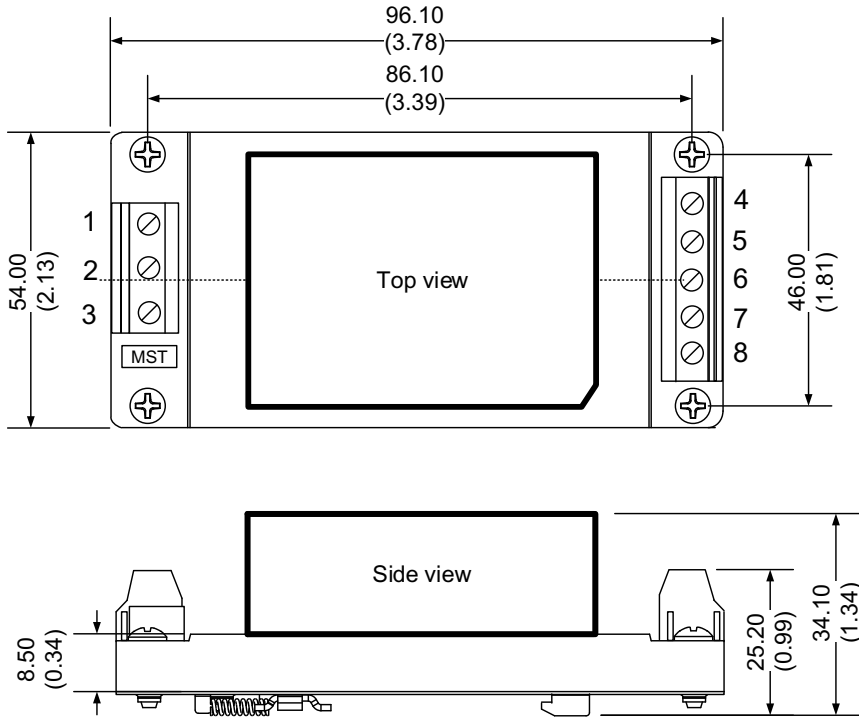

Pin Out Specifications

Pin	Single
1	Earth/Ground
2	AC Input (N)
3	AC Input (L)
4	- V output
5	No Connection
6	No Connection
7	No Connection
8	+ V output

Dimensions: mm (inch)
 General Tolerance: ± 1.00 (0.04)
 Holding holes tolerance: ± 0.20 (0.01)
 Wire gauge: 24-12AWG
 DIN rail type: TS35

Derating

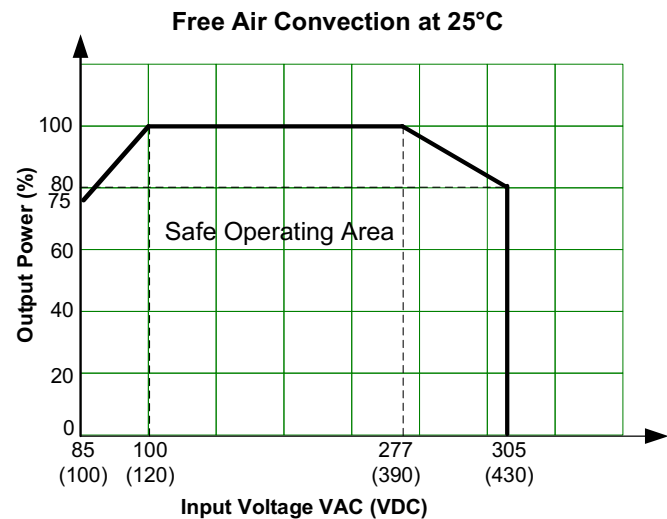
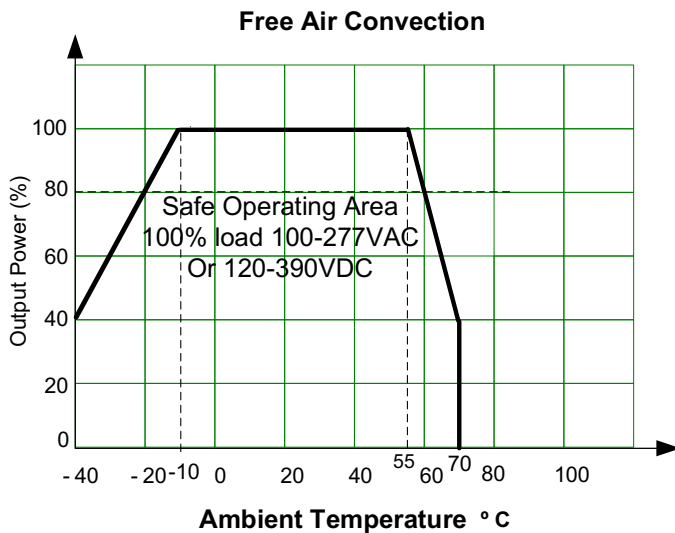

NOTE: **1.** Datasheets are updated as needed and as such, specifications are subject to change without notice. Once printed or downloaded, datasheets are no longer controlled by Aimtec; refer to www.aimtec.com for the most current product specifications. **2.** Product labels shown, including safety agency certifications on labels, may vary based on the date manufactured. **3.** Mechanical drawings and specifications are for reference only. **4.** All specifications are measured at an ambient temperature of 25°C, humidity<75%, nominal input voltage and at rated output load unless otherwise specified. **5.** Aimtec may not have conducted destructive testing or chemical analysis on all internal components and chemicals at the time of publishing this document. CAS numbers and other limited information are considered proprietary and may not be available for release. **6.** This product is not designed for use in critical life support systems, equipment used in hazardous environments, nuclear control systems or other such applications which necessitate specific safety and regulatory standards other the ones listed in this datasheet. **7.** Warranty is in accordance with Aimtec's standard Terms of Sale available at www.aimtec.com.