

FEATURES:

Picture coming soon

- I/O Isolation 3000VAC
- Operating Temp: -40°C to +70°C
- Over current Protection
- Input: 85-305VAC, 47-63Hz, or 100-430VDC
- Low Ripple and Noise
- Over Voltage Protection
- Up to 85% efficiency
- Short Circuit Protection

Models Single output



Model	Input Voltage (VAC/Hz)	Input Voltage (VDC)	Max Output wattage (W)	Output Voltage (V)	Output Current max (A)	Maximum capacitive load (µF)	Efficiency (%)
							230 VAC
AME15-3.3SJZ	85-305/47-63	100-430	9.9	3.3	3	36000	74
AME15-5SJZ	85-305/47-63	100-430	14	5	2.8	20000	78
AME15-9SJZ	85-305/47-63	100-430	15	9	1.6	6000	79
AME15-12SJZ	85-305/47-63	100-430	15	12	1.25	3000	82
AME15-15SJZ	85-305/47-63	100-430	15	15	1	3000	82
AME15-24SJZ	85-305/47-63	100-430	15	24	0.625	900	84
AME15-48SJZ	85-305/47-63	100-430	15	48	0.32	370	85

Note:
*Add suffix “-ST” for optional screw terminal bottom plate, add suffix “-STD” for optional DIN Rail screw terminal bottom plate

Input Specifications

Parameters	Conditions	Typical	Maximum	Units
Current (full load)	115 VAC		370	mA
	230 VAC		220	mA
Inrush current <2ms (cold start)	115 VAC	10		A
	230 VAC	20		A
Leakage current			0.25	mA
External fuse	Recommended slow blow type	2		A

Output Specifications

Parameters	Conditions	Typical	Maximum	Units
Voltage accuracy		±2		%
Line regulation	(LL-HL)	±0.5		%
Load regulation	10-100% load	±1		%
Ripple & Noise			100	mV p-p
Hold-up time	115 VAC	15		ms
	230 VAC	80		ms

Isolation Specifications

Parameters	Conditions	Typical	Rated	Units
Tested I/O voltage	Input to Output, 60 sec		3000	VAC
	Input to Ground		2000	
Isolation resistance		>1000		MΩ

General Specifications

Parameters	Conditions	Typical	Maximum	Units
Switching frequency		65		KHz
Over current protection		≥110		% of Iout
Over voltage protection		Zener Diode Clamp		
Short circuit protection		Auto recovery		
Operating temperature	See derating curve	-40 to +70		°C
Maximum case temperature			100	°C
Storage temperature		-40 to +105		°C

General Specifications (continued)

Parameters	Conditions	Typical	Maximum	Units
Temperature coefficient		±0.02		% / °C
Cooling		Free air convection		
Humidity	Non condensing		95	% RH
Case material		Plastic (flammability to UL 94V-0)		
Weight	Pin mountable	85		g
	Screw terminal bottom plate	135		
	DIN Rail screw terminal bottom plate	175		
Dimensions (L x W x H)	Pin mountable	62.0 x 45.0 x 22.5 mm (2.44 x 1.77 x 0.89 inches)		
	Screw terminal bottom plate	96.1 x 54.0 x 31.0 mm (3.78 x 2.13 x 1.22 inches)		
	DIN Rail screw terminal bottom plate	96.1 x 54.0 x 35.6 mm (3.78 x 2.13 x 1.40 inches)		
MTBF		> 300 000 hrs (MIL-HDBK -217F, t _a =+25°C)/ Full Load		

NOTE: All specifications in this datasheet are measured at an ambient temperature of 25°C, humidity<75%, nominal input voltage (115/230VAC) and at rated output load unless otherwise specified.

Safety Specifications

Parameters		
Agency approvals	CE, UL	
Standards	Information Technology Equipment	IEC/EN/UL 60950-1
	EMI - Conducted and radiated emission	EN55022, class B EN55024: 2010
	Electrostatic Discharge Immunity	IEC 61000-4-2: Contact ±6KV/Air ±8KV, Criteria B
	RF, Electromagnetic Field Immunity	IEC 61000-4-3: 10V/m, Criteria A
	Electrical Fast Transient/Burst Immunity	IEC 61000-4-4: ±2KV, Criteria B
	Surge Immunity	IEC 61000-4-5: ±1KV/±2KV, Criteria B
	RF, Conducted Disturbance Immunity	IEC 61000-4-6: 10Vrms, Criteria A
	Power frequency Magnetic Field Immunity	IEC 61000-4-8: 10A/m, Criteria A
	Voltage dips, Short Interruptions Immunity	IEC 61000-4-11: 0-70%, Criteria B

Typical Application circuit

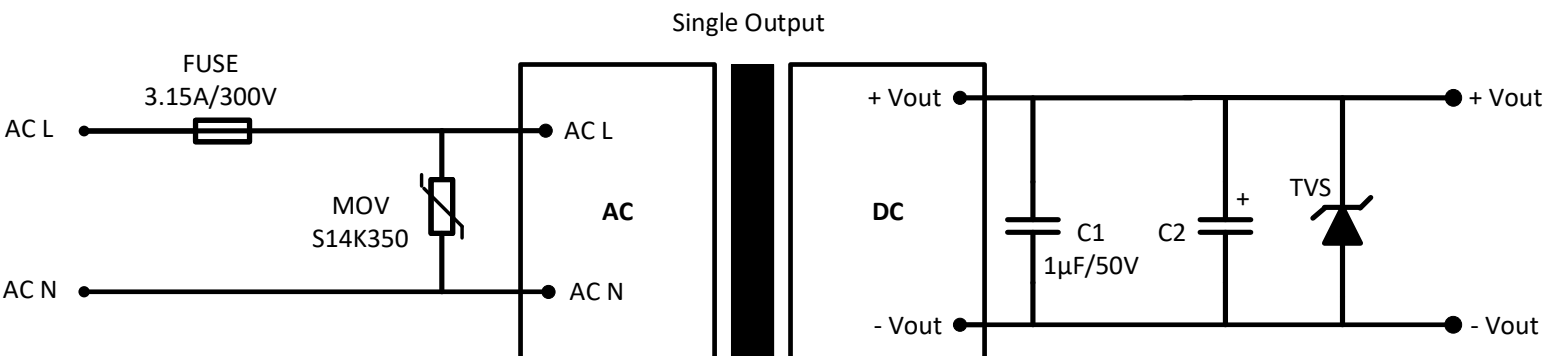

Vout	C2	TVS
3.3V & 5V	680 µF/50V	7A
9V	470 µF/50V	12A
12V & 15V	220 µF/50V	20A
24V	68 µF/50V	30A
48V	33 µF/50V	64A

Dimensions

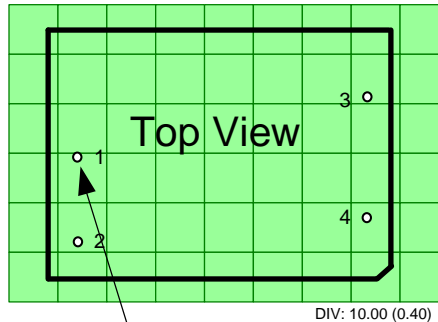
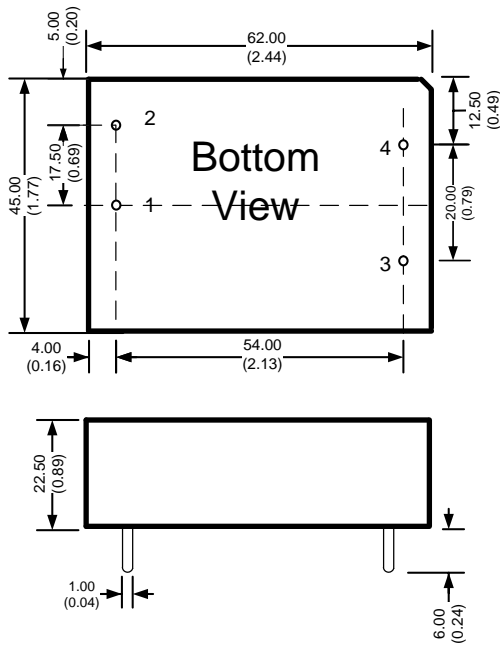

Dimensions mm (inch)
Case Tolerance ± 0.50 (± 0.02)
Pin Diameter 1.0 ± 0.10 (0.04 ± 0.004)

Pin Out Specifications

Pin	Single
1	AC Input (N)
2	AC Input (L)
3	- V output
4	+ V output

Dimensions with optional ST model

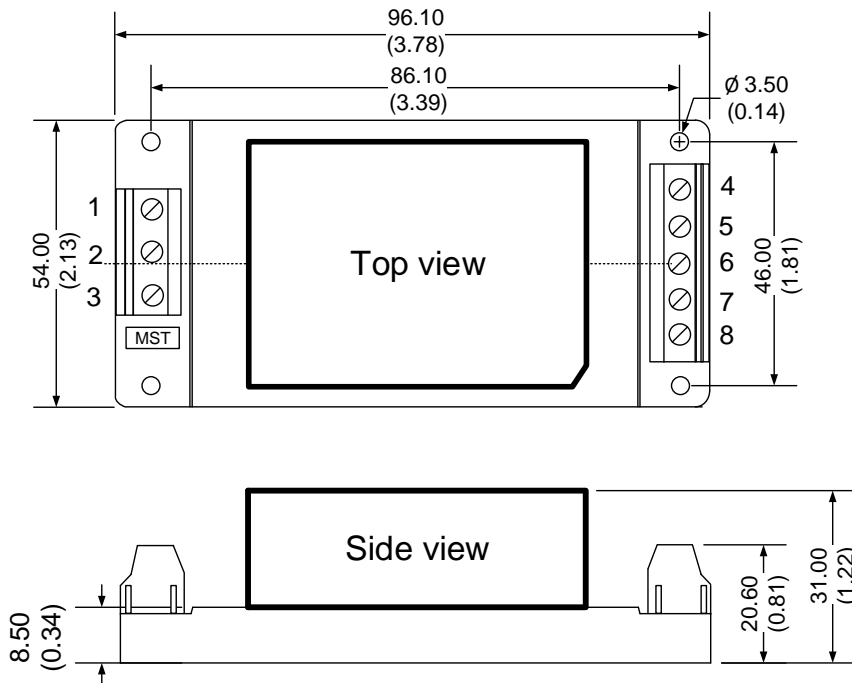

Pin Out Specifications

Pin	Single
1	No Connection
2	AC Input (N)
3	AC Input (L)
4	- V output
5	No Connection
6	No Connection
7	No Connection
8	+ V output

Dimensions: mm (inch)
Case Tolerance: ± 1.00 (0.04)
Holding holes tolerance: ± 0.20 (0.01)
Wire gauge: 24-12AWG

Dimensions with optional STD model

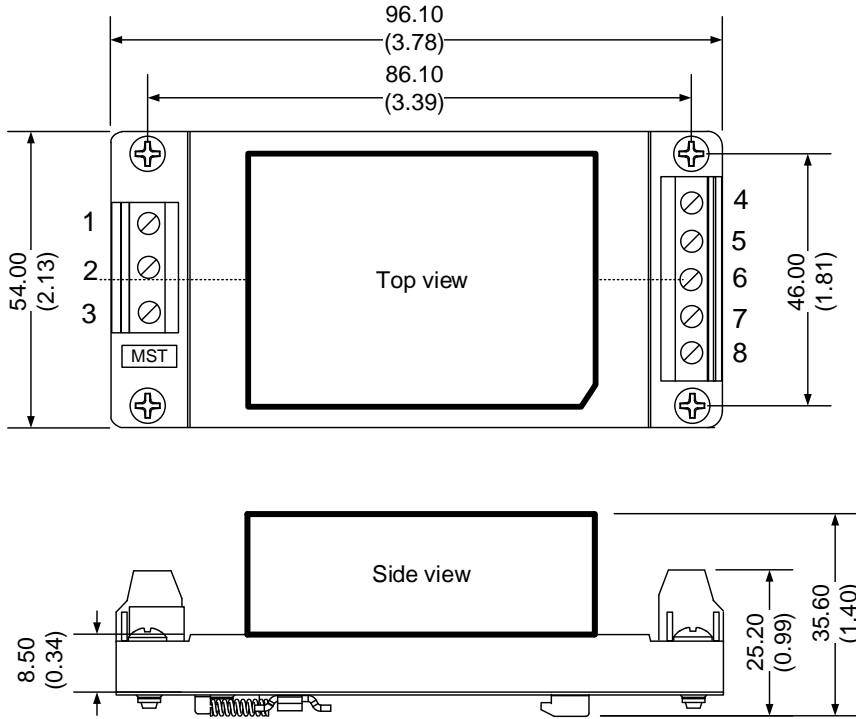

Pin Out Specifications

Pin	Single
1	No Connection
2	AC Input (N)
3	AC Input (L)
4	- V output
5	No Connection
6	No Connection
7	No Connection
8	+ V output

Dimensions: mm (inch)
 General Tolerance: ± 1.00 (0.04)
 Holding holes tolerance: ± 0.20 (0.01)
 Wire gauge: 24-12AWG
 DIN rail type: TS35

Derating

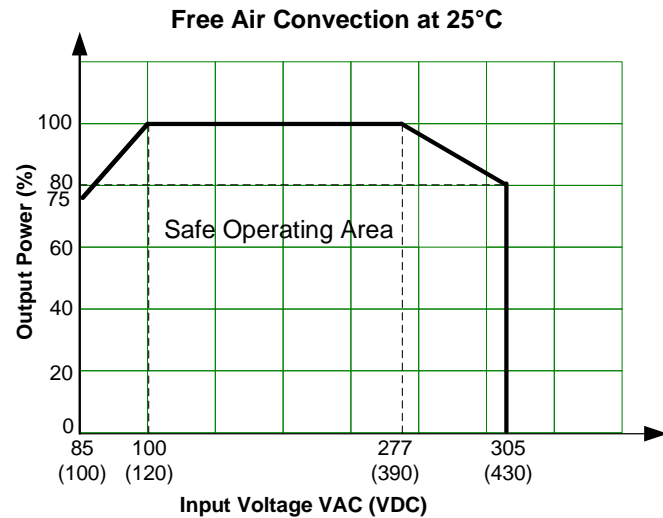
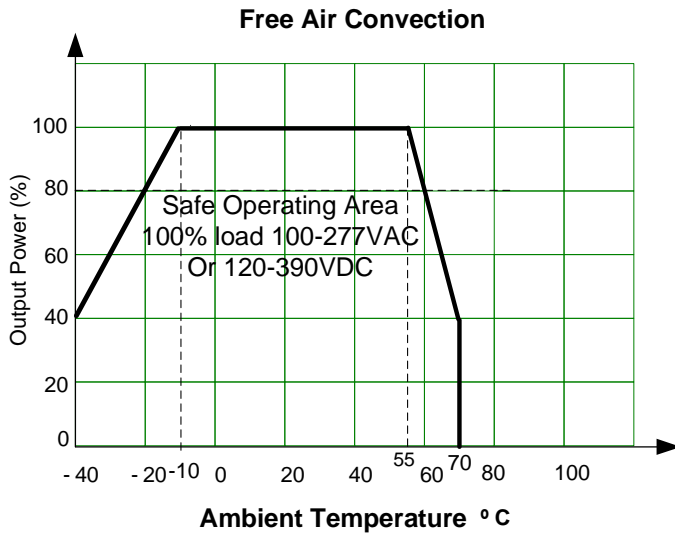

NOTE: 1. Datasheets are updated as needed and as such, specifications are subject to change without notice. Once printed or downloaded, datasheets are no longer controlled by Aimtec; refer to www.aimtec.com for the most current product specifications. **2.** Product labels shown, including safety agency certifications on labels, may vary based on the date manufactured. **3.** Mechanical drawings and specifications are for reference only. **4.** All specifications are measured at an ambient temperature of 25°C, humidity < 75%, nominal input voltage and at rated output load unless otherwise specified. **5.** Aimtec may not have conducted destructive testing or chemical analysis on all internal components and chemicals at the time of publishing this document. CAS numbers and other limited information are considered proprietary and may not be available for release. **6.** This product is not designed for use in critical life support systems, equipment used in hazardous environments, nuclear control systems or other such applications which necessitate specific safety and regulatory standards other than the ones listed in this datasheet. **7.** Warranty is in accordance with Aimtec's standard Terms of Sale available at www.aimtec.com.