

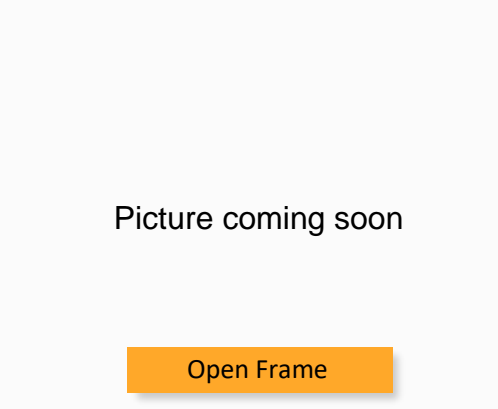

AMEOF15-277NZ



The AMEOF15-277NZ series is one of Aimtec highly efficient green 15W AC-DC converters. They feature an ultra-wide wide input range accepting either AC or DC voltage, high efficiency, low power consumption and CLASS II reinforced insulation.

This series offers great operating temperatures, from -40°C to 85°C and an isolation of 3000VAC for improved reliability and system safety. Furthermore, a high MTBF of 300,000h, output short circuit protection (OSCP), output over-current protection (OCP) and output over-voltage protection (OVP) come standard with the series.

The converter can be configured to meet class A or class B of the CISPR32/EN55032 standard. This series is suitable for industrial control, electric power, instrumentation and smart home applications with dimensional constraints.

Features

- Universal Input: 85 - 305VAC/100 - 430VDC
- Operating Temp: -40 °C to +85 °C
- High isolation voltage: 3000VAC
- Low ripple & noise, 150mV(p-p), max.
- Output short circuit, over-current, and over-voltage protection

Summary

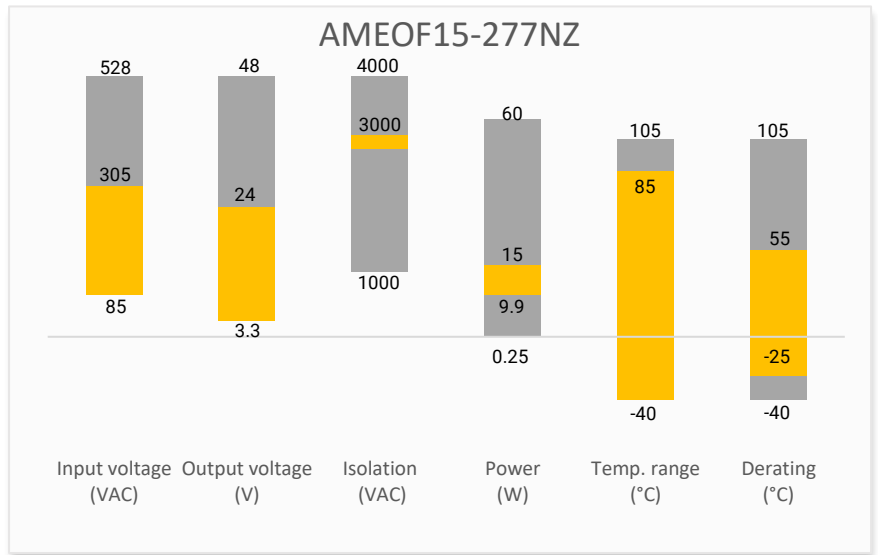

Training



Product Training Video
(click to open)



Press Release

Coming Soon!

Application Notes

Applications



Models & Specifications



Single Output Straight Pins

Model	Input Voltage (VAC/Hz)	Input Voltage (VDC)	Max Output wattage (W)	Output Voltage (V)	Output Current max (A)	Maximum capacitive load (μ F)	Efficiency @ 230VAC (%)
AMEOF15-03S277NZ	85~305/47~63	100~430	9.9	3.3	3	20000	75
AMEOF15-05S277NZ	85~305/47~63	100~430	14	5	2.8	15000	77
AMEOF15-09S277NZ	85~305/47~63	100~430	15	9	1.67	5000	82
AMEOF15-12S277NZ	85~305/47~63	100~430	15	12	1.25	4000	82
AMEOF15-15S277NZ	85~305/47~63	100~430	15	15	1	2000	84
AMEOF15-24S277NZ	85~305/47~63	100~430	15	24	0.625	1000	85

Single Output Bended Pins

Model	Input Voltage (VAC/Hz)	Input Voltage (VDC)	Max Output wattage (W)	Output Voltage (V)	Output Current max (A)	Maximum capacitive load (μ F)	Efficiency @ 230VAC (%)
AMEOF15-03SL277NZ	85~305/47~63	100~430	9.9	3.3	3	20000	75
AMEOF15-05SL277NZ	85~305/47~63	100~430	14	5	2.8	15000	77
AMEOF15-09SL277NZ	85~305/47~63	100~430	15	9	1.67	5000	82
AMEOF15-12SL277NZ	85~305/47~63	100~430	15	12	1.25	4000	82
AMEOF15-15SL277NZ	85~305/47~63	100~430	15	15	1	2000	84
AMEOF15-24SL277NZ	85~305/47~63	100~430	15	24	0.625	1000	85

Input Specifications

Parameters	Conditions	Typical	Maximum	Units
Input current	115VAC		400	mA
	230VAC		250	mA
Inrush current	115VAC	18		A
	230VAC	35		A
Leakage	277VAC/50Hz		0.25	mA RMS
Input fuse	1A Slow-blow type, required			

Output Specifications

Parameters	Conditions	Typical	Maximum	Units
Voltage accuracy	3.3Vout	± 3		%
	Others	± 2		%
Line regulation	Full load	± 0.5		%
Load regulation	0-100% load, 3.3Vout	± 2		%
	0-100% load, 5Vout	± 1.5		%
	0-100% load, others	± 1		%
Ripple & Noise	20MHz bandwidth	80	150	mV p-p
Hold-up time	115VAC	10		ms
	230VAC	40		ms

Isolation Specifications				
Parameters	Conditions	Typical	Rated	Units
Tested I/O voltage	60 sec, 5mA max		3000	VAC

General Specifications				
Parameters	Conditions	Typical	Maximum	Units
Switching frequency		65		kHz
Operating temperature		-40 to +85		°C
Storage temperature		-40 to +105		°C
No-load power consumption	230VAC	0.1	0.25	W
Temperature coefficient		±0.02		% / °C
Short circuit protection	Hiccup, Continuous, Auto recovery			
Over current protection	Auto recovery	≥ 110		% of Iout
Over voltage protection	3.3/5Vout		9	VDC
	9Vout		12	VDC
	12Vout		16	VDC
	15Vout		20	VDC
	24Vout		30	VDC
Power derating	-40 °C to -25 °C	≥ 4		% / °C
	+55 °C to +70 °C	≥ 3.34		% / °C
	+70 °C to +85 °C	≥ 2.67		% / °C
	85VAC to 100VAC	≥ 1.67		% / VAC
	277VAC to 305VAC	≥ 0.72		% / VAC
Safety class	Class II			
Cooling	Free air convection			
Storage Humidity			95	% RH
Soldering temperature	Wave soldering, duration 5 to 10s	260 ± 5		°C
	Manual soldering, duration 3 to 5s	360 ± 10		°C
Weight		11		g
Dimensions (L x W x H)	1.75 x 0.94 x 0.60 inches (44.50 x 24.00 x 15.00mm)			
MTBF	> 1 000 000 hrs (MIL-HDBK -217F, t=+25°C)			
NOTE: All specifications in this datasheet are measured at an ambient temperature of 25°C, humidity<75%, nominal input voltage and at rated output load unless otherwise specified.				

Safety Specifications		
Parameters		
Agency approvals	UL 62368-1	
Standards	Design to meet ICE/EN62368-1, EN60335 (With the recommended EMC circuit for EN60335)	
	EMC - Conducted and radiated emission	CISPR32 / EN55032 Class A, (With typical application circuit, EMI Class A circuit) CISPR32 / EN55032 Class B, (With EMI Class B circuit)
	Electrostatic Discharge Immunity	IEC 61000-4-2 Contact ±6KV, Criteria B
	RF, Electromagnetic Field Immunity	IEC 61000-4-3 10V/m, Criteria A
	Electrical Fast Transient/Burst Immunity	IEC 61000-4-4 ±2KV, Criteria B (With typical application circuit, EMS Class III circuit) IEC 61000-4-4 ±4KV, Criteria B (With EMS Class IV circuit)
	Surge Immunity	IEC 61000-4-5 L-L ±1KV, Criteria B (With typical application circuit, EMS Class III circuit) IEC 61000-4-5 L-L ±2KV, Criteria B (With EMS Class IV circuit)
	RF, Conducted Disturbance Immunity	IEC 61000-4-6 10Vr.m.s, Criteria A
	Voltage dips, Short Interruptions Immunity	IEC 61000-4-11 0%, 70%, Criteria B

Derating

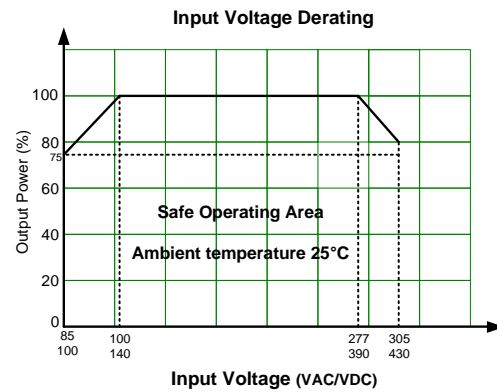
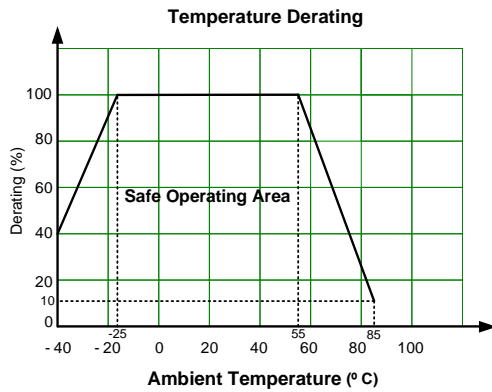

Dimensions

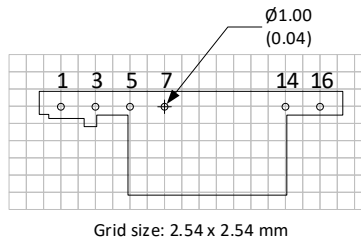
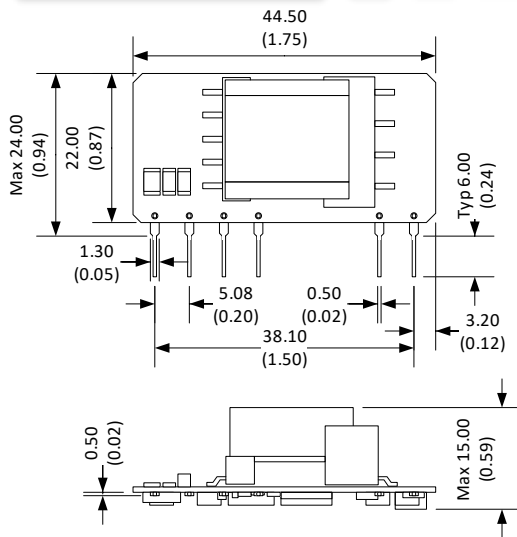

Pin Output Specifications	
Pin	Function
1	AC Input (N)
3	AC Input (L)
5	+V_Cap
7	-V_Cap
14	-V Output
16	+V Output

Note:

1. Capacitor between pin5 and pin7 is necessary.
2. External circuit on the output side is necessary. Please refer to the recommended circuit.
3. It is needed to have creepage $\geq 6.4\text{mm}$ and clearance $\geq 4\text{mm}$ for safety between external components in primary circuit and secondary circuit.
4. The layout of the device is for reference only, please refer to the actual product.

Dimensions for L model

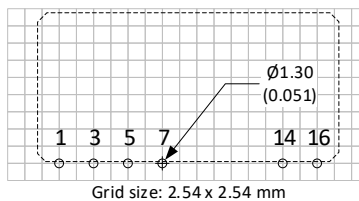
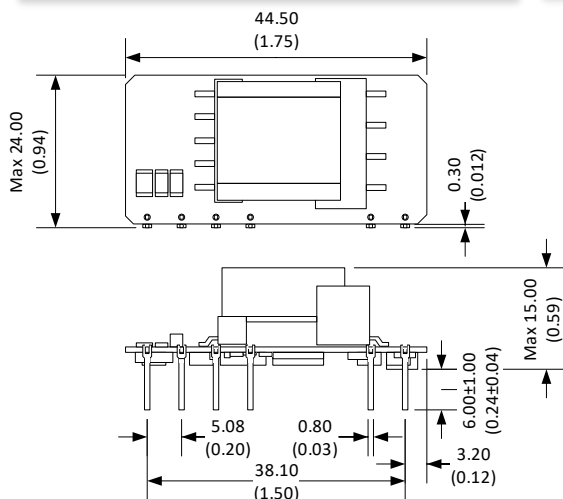

Note:
Unit: mm [inch]
Pin tolerance: ± 0.10 (± 0.004)
General tolerance: ± 0.50 (± 0.020)

Recommended EMC external circuit

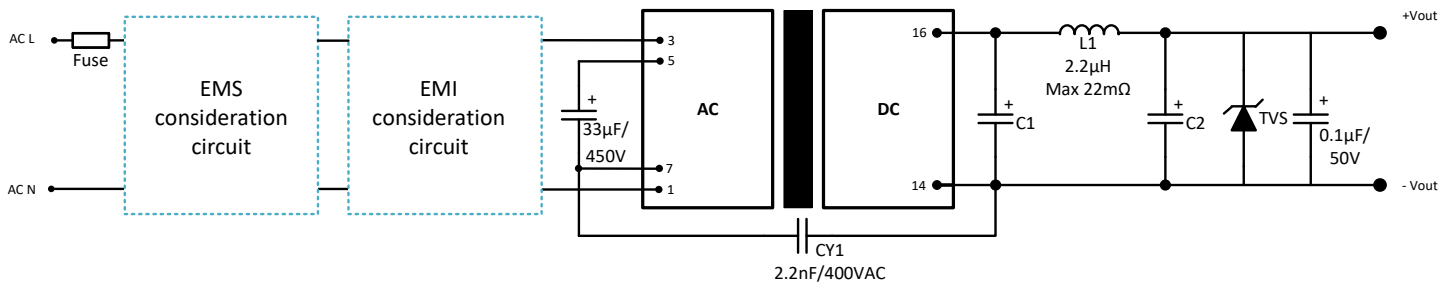

A suppressor diode (TVS) with 1.2 times of the output voltage rating is recommended.
A inductor (L1) with 1.2 times of the output current rating is recommended.

EMI & EMS Recommended Circuit

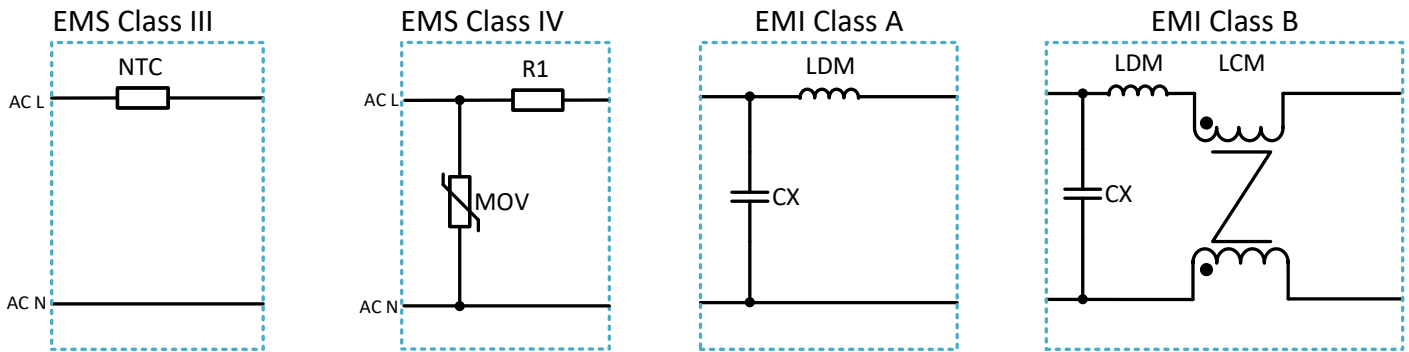

Component	EMS		EMI	
	Class III	Class IV	CLASS A	CLASS B
MOV	-	14D561K	-	-
R1	-	12Ω/3W	-	-
CX	-	-	0.1µF/310VAC	0.22µF/310VAC
NTC	10D-10	-	-	-
LCM	-	-	-	10mH (0.4-0.6Ω)
LDM	-	-	1.2Mh (0.4-4Ω)	0.33mH (0.4-1Ω)
FUSE	1A/300V	2A/300V	1A/300V	1A/300V

Model	C1	C2	TVS
3.3 VDC output	470µF/16V (Solid capacitor)	220µF/16V	7V
5 VDC output	470µF/16V (Solid capacitor)	220µF/16V	7V
9 VDC output	470µF/16V (Solid capacitor)	220µF/16V	12V
12 VDC output	470µF/16V (Solid capacitor)	220µF/16V	20V
15 VDC output	680µF/25V	220µF/35V	20V
24 VDC output	470µF/35V	220µF/35V	30V

Typical application circuit

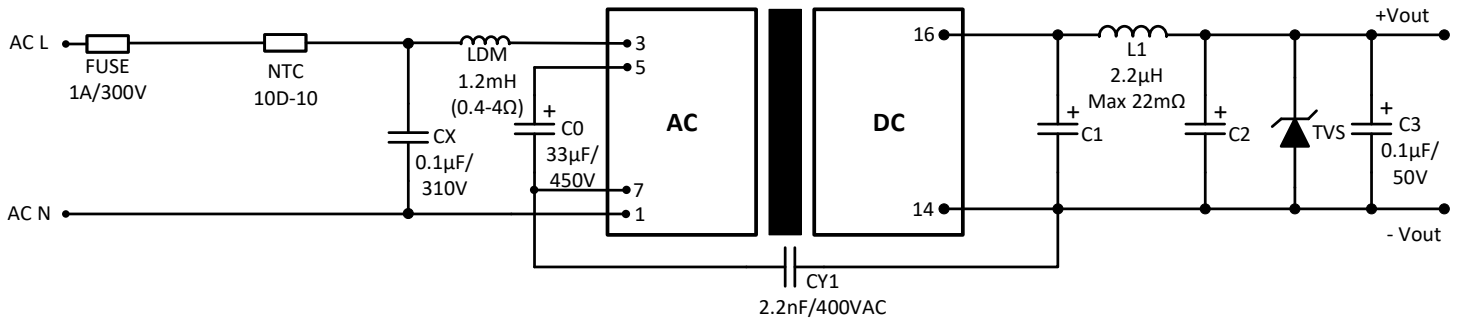

Recommended EMC circuit for EN60335

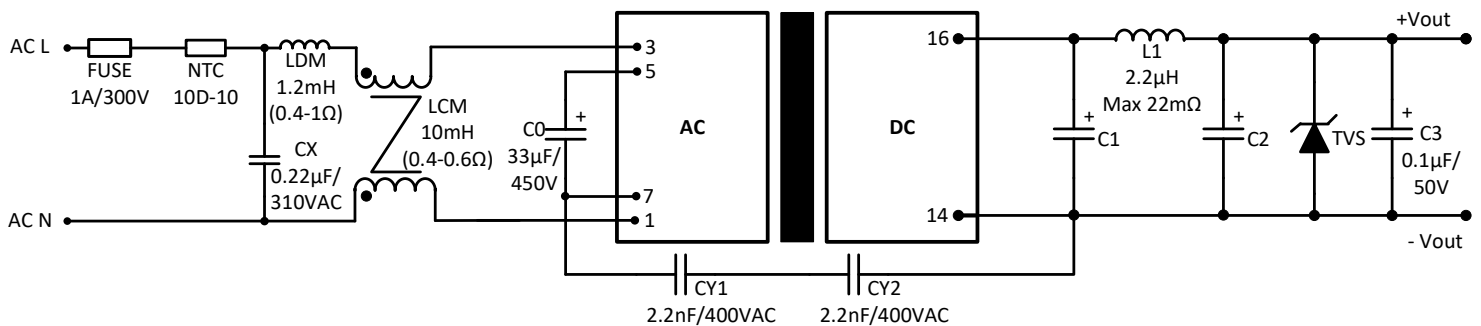

NOTE: 1. Datasheets are updated as needed and as such, specifications are subject to change without notice. Once printed or downloaded, datasheets are no longer controlled by Aimtec; refer to www.aimtec.com for the most current product specifications. 2. Product labels shown, including safety agency certifications on labels, may vary based on the date manufactured. 3. Mechanical drawings and specifications are for reference only. 4. All specifications are measured at an ambient temperature of 25°C, humidity<75%, nominal input voltage and at rated output load unless otherwise specified. 5. Aimtec may not have conducted destructive testing or chemical analysis on all internal components and chemicals at the time of publishing this document. CAS numbers and other limited information are considered proprietary and may not be available for release. 6. This product is not designed for use in critical life support systems, equipment used in hazardous environments, nuclear control systems or other such applications which necessitate specific safety and regulatory standards other the ones listed in this datasheet. 7. Warranty is in accordance with Aimtec's standard Terms of Sale available at www.aimtec.com.