

# Series AMSRB1-78JZ

## Up to 15 Watt | DC-DC Switching Regulator

### FEATURES:

- Switching Regulator
- Low Quiescent Current
- Negative output available
- Non-Isolated
- Meet EN 62368 Standard
- SMD Package
- Efficiency Up To 96%
- Short Circuit Protection
- High MTBF
- RoHS Compliant

Picture Coming Soon

### Models Single output



Model	Input Voltage (V)	Output Voltage (V)	Output Current max (mA)	Efficiency	Efficiency
				Vin Max	Vin Min
				(%)	(%)
AMSRB1-783.3JZ	6-36	3.3	1000	80	90
AMSRB1-7805JZ	8-36	5	1000	85	93
	8-27	-5	-500	81	85
AMSRB1-7809JZ	13-36	9	1000	89	94
AMSRB1-7812JZ	16-36	12	1000	92	95
	8-20	-12	-300	87	88
AMSRB1-7815JZ	20-36	15	1000	93	96
	8-18	-15	-300	88	87

NOTE: All specifications in this datasheet are measured at an ambient temperature of 25°C, humidity<75%, for input voltage higher than 30 VDC, a 22uF/50V input capacitor is required. Nominal input voltage and at rated output load unless otherwise specified.

### Input Specifications

Parameters	Nominal	Typical	Maximum	Units
Voltage range	See Models table above			
Quiescent Current	Positive output	0.3	1	mA
	Negative output	1	4	mA
Reverse Polarity Input	Prohibited			
Filter	Capacitor			

### Output Specifications

Parameters	Conditions	Typical	Maximum	Units	
Voltage accuracy	At 100% load	3.3V output	±2	±4	%
		Others	±1.5	±3	
Short Circuit protection	Continuous, hiccup mode				
Short circuit restart	Auto-Recovery				
Dynamic load stability	Nominal input voltage, 25% load step change	±60	±200	mV	
Transient recovery time	Nominal input voltage, 25% load step change		1	ms	
Line voltage regulation	Vin=(LL-HL) at full load	±0.2	±0.4	%	
Load voltage regulation	Nominal input, 10%-100% load	Positive output	±0.4	±0.6	%
		Negative output	±0.4	±0.8	
Temperature coefficient	Full load		±0.03	%/°C	
Ripple & Noise*	20MHz Bandwidth, 20% to 100% load	25	75	mV p-p	
Maximum Capacitive Load	Positive output		680	uF	
	Negative output		330		

NOTE:

\*1. Ripple and noise tested with "parallel cable" method, please refer to DC-DC Converter Application Notes for specific operation methods;

\*2. With the load lower than 20%, the maximum ripple and noise of 3.3V/5V output products will be 100mVp-p, 9V/12V/15V output products will be 2%Vo.

### General Specifications

Parameters	Conditions	Typical	Maximum	Units
Switching frequency	100% load	520		KHz
Operating temperature	With derating (see graph below)	-40 to +85		°C
Storage temperature		-55 to +125		°C
Maximum case temperature			100	°C
Cooling	Free Air Convection			
Humidity	Non-condensing		95	% RH
Case material	Plastic (UL94-V0)			
Weight		1.9		g
Dimensions (L x W x H)	0.46 x 0.31 x 0.41 Inches (11.6 x 8.0 x 10.4 mm)			
MTBF	> 2 000 000 hrs (MIL-HDBK-217F, Ground Benign, t=+25 °C)			
Maximum Soldering Temperature	Welding time: 10s (Max.)		260	°C

### Pin Out Specifications

Pin	Positive output	Negative output
1	+V input	+V input
2	Ground	-V output
3	+V output	Ground

### Safety Specifications

Parameters		
Standards	Information Technology Equipment	Design to meet EN 62368
	EMI - Conducted and radiated emission	CISPR32 / EN55032, class B (with the recommended EMI circuit)
	Electrostatic Discharge Immunity	IEC 61000-4-2, Contact ±4KV, Criteria B
	RF, Electromagnetic Field Immunity	IEC 61000-4-3, 10V/m, Criteria A
	Electrical Fast Transient / Burst Immunity	IEC 61000-4-4, ±1KV, Criteria B, with the recommended EMS circuit
	Surge Immunity	IEC 61000-4-5, L-L ±1KV, Criteria B, with the recommended EMS circuit
	RF, Conducted Disturbance Immunity	IEC 61000-4-6, 3 Vrms, Criteria A

### Dimensions & PCB Foot Print

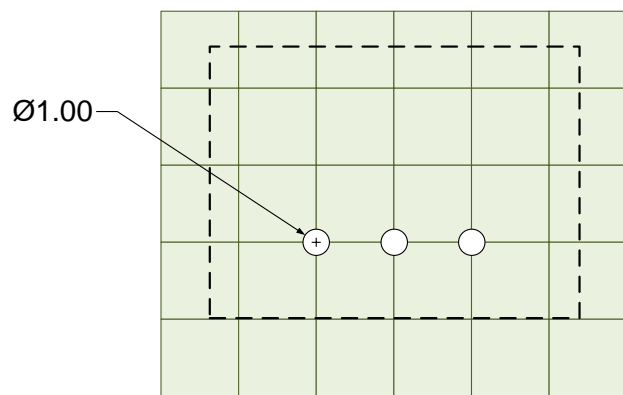
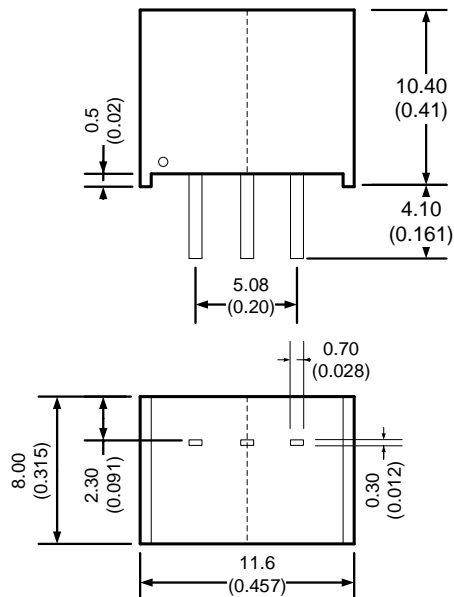

## Derating

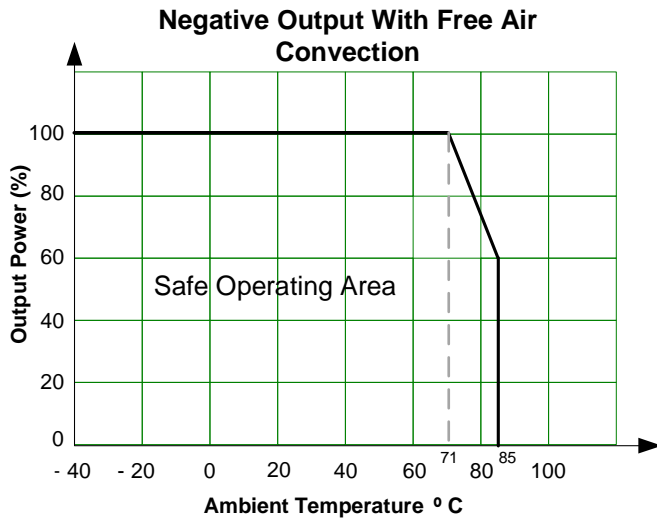
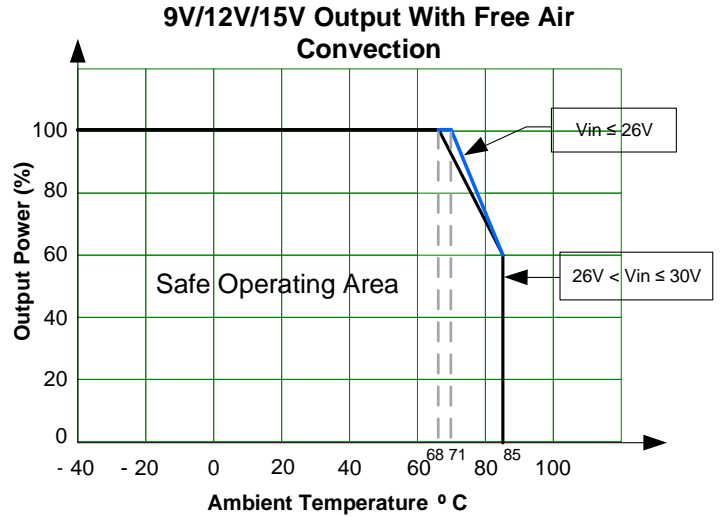
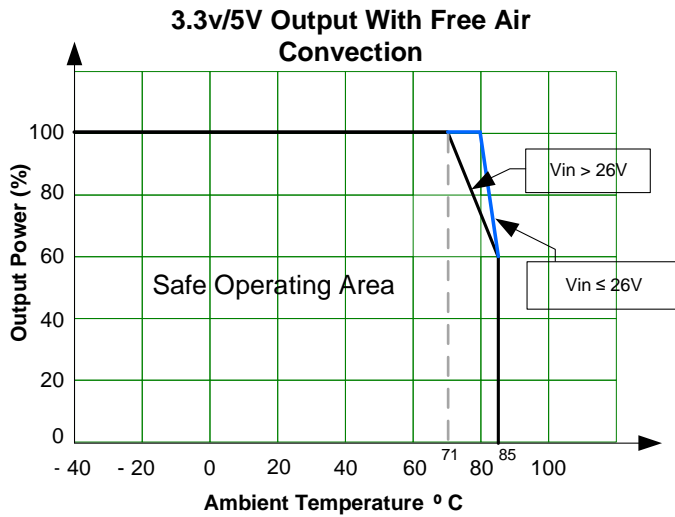

## Application Circuit

**Positive Output Typical Application Circuit**

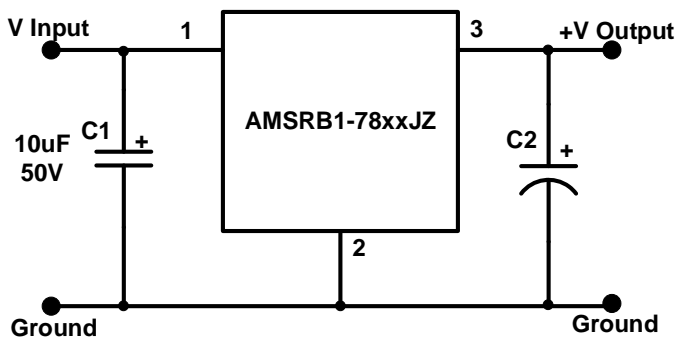

**Negative Output Typical Application Circuit**

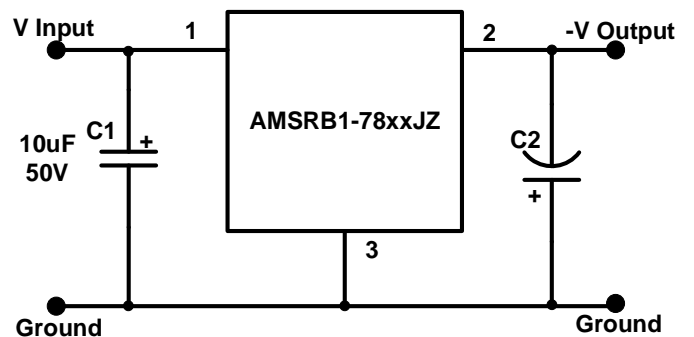

**Positive and Negative dual output application circuit**

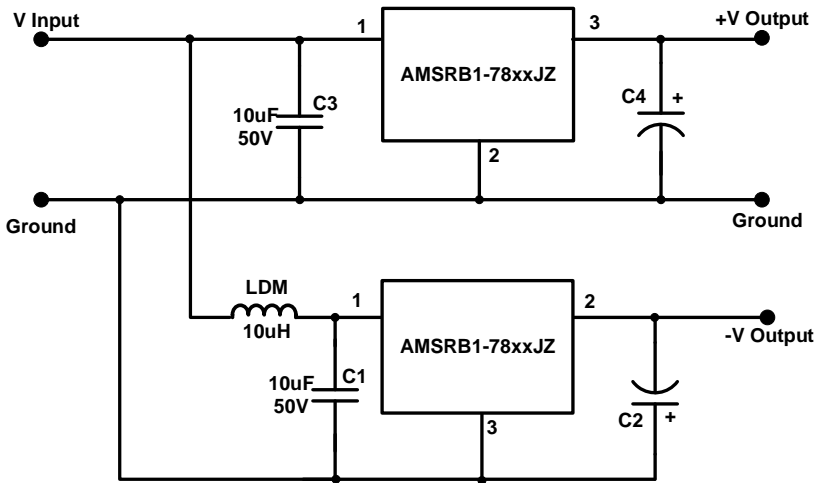

Model	C2/C4 (uF)
3.3/5V output	22uF / 10V
9V output	22uF / 16V
12/15V output	22uF / 25V

It is recommended that tantalum capacitor and aluminum electrolytic capacitor of low ESR capacitors are used for C2. C1/C3 & C2/C4 are required and should be installed as close to the converter as possible. The converter cannot be used in parallel to enlarge the power for output and hot swap.

**EMC Recommended Circuits**

**Positive output**

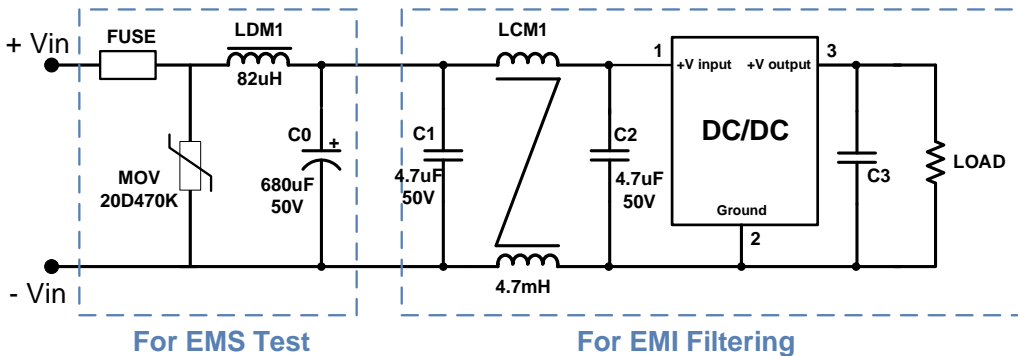

**Negative output**

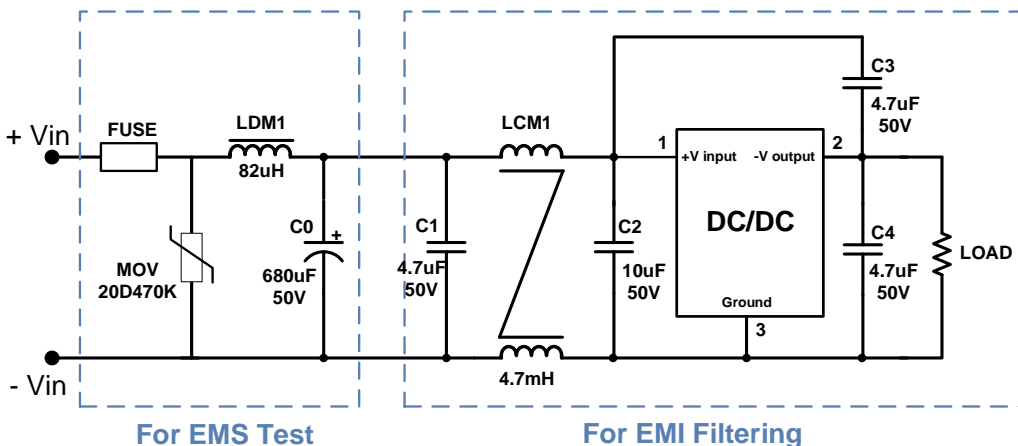

The part choice of the FUSE is based on actual input current.

**NOTE:** **1.** Datasheets are updated as needed and as such, specifications are subject to change without notice. Once printed or downloaded, datasheets are no longer controlled by Aimtec; refer to [www.aimtec.com](http://www.aimtec.com) for the most current product specifications. **2.** Product labels shown, including safety agency certifications on labels, may vary based on the date manufactured. **3.** Mechanical drawings and specifications are for reference only. **4.** All specifications are measured at an ambient temperature of 25°C, humidity<75%, nominal input voltage and at rated output load unless otherwise specified. **5.** Aimtec may not have conducted destructive testing or chemical analysis on all internal components and chemicals at the time of publishing this document. CAS numbers and other limited information are considered proprietary and may not be available for release. **6.** This product is not designed for use in critical life support systems, equipment used in hazardous environments, nuclear control systems or other such applications which necessitate specific safety and regulatory standards other the ones listed in this datasheet. **7.** Warranty is in accordance with Aimtec's standard Terms of Sale available at [www.aimtec.com](http://www.aimtec.com).