



FEATURES:

- Continuous Short Circuit Protection
- Operating temperature -40°C to +85°C
- Ultra-low no load power consumption
- Pin Compatible to LM78xx
- Pin Compatible to LM78xx
- Very high efficiency up to 96%
- Non-Isolated
- Regulated Outputs



Models Single output

Model	Input Voltage Nom/Range (V)	Output Voltage (V)	Output Current max (mA)	Efficiency Vin Min (%)	Efficiency Vin Max (%)	Max. Capacitive load (µF)
AMSRI1-783.3-NZ	24 / 6-36	3.3	1000	90	81	680
AMSRI1-7805-NZ	24 / 8-36	5	1000	93	86	680
	12 / 8-27	-5	-500	86	82	330
AMSRI1-7809-NZ	24 / 13-36	9	1000	95	90	680
AMSRI1-7812-NZ	24 / 16-36	12	1000	96	93	680
	12 / 8-20	-12	-300	89	88	330
AMSRI1-7815-NZ	24 / 20-36	15	1000	96	94	680
	12 / 8-18	-15	-300	89	89	330
AMSRI1-783.3L-NZ	24 / 6-36	3.3	1000	90	81	680
AMSRI1-7805L-NZ	24 / 8-36	5	1000	93	86	680
	12 / 8-27	-5	-500	86	82	330
AMSRI1-7809L-NZ	24 / 13-36	9	1000	95	90	680
AMSRI1-7812L-NZ	24 / 16-36	12	1000	96	93	680
	12 / 8-20	-12	-300	89	88	330
AMSRI1-7815L-NZ	24 / 20-36	15	1000	96	94	680
	12 / 8-18	-15	-300	89	89	330

Note: For higher than 30VDC input, adding 22µF/50V capacitor required.

Input Specifications

Parameters	Conditions	Typical	Maximum	Units
Voltage range	See the table above			
Filter	Capacitor			
No load input current	Positive output	0.1	1	mA

Output Specifications

Parameters	Conditions	Typical	Maximum	Units
Voltage accuracy	100% load	±2	±4	%
Short Circuit protection	Continuous, auto recovery			
Line voltage regulation	Vin=(LL-HL) at full load	±0.2	±0.4	%
Load voltage regulation	10-100% load	±0.4	±0.6	%
Temperature coefficient	Full temperature range	±0.03		%/°C
Ripple & Noise	20MHz Bandwidth, 20 – 100% load	20	75	mV p-p
Transient response deviation	Nom Vin, 25% load step change	50	300	mV
Transient recovery time		0.1	1	ms

General Specifications

Parameters	Conditions	Typical	Maximum	Units
Switching frequency	100% load, 3.3V and 5V output	520	620	KHz
	100% load, others	680	780	
Operating temperature	With derating above 71°C	-40 to +85		°C
Storage temperature		-55 to +125		°C
Max Case temperature			100	°C
Cooling	Free air convection			
Humidity	Non-condensing		95	%
Case material	Heat resistant black plastic (UL94V-0 rated)			
Weight		3.8		g
Dimensions (L x W x H)	0.45 x 0.35 x 0.69 inches	11.5 x 9 x 17.5 mm		

MTBF	>2 000 000 hrs (MIL-HDBK-217F, Ground Benign, t=+25°C)		
Soldering Temperature	1.5 mm from case for 10 sec	260	°C

NOTE: All specifications in this datasheet are measured at an ambient temperature of 25°C, humidity<75%, nominal input voltage and at rated output load unless otherwise specified.

Safety Specifications

Parameters	
Standards	IEC/UL 60950-1
	EN55022: 2006 + A1:2007, Class B (with recommended circuit)
	IEC61000-4-2 (ESD): Contact ±4KV, Perf. Criteria B
	IEC61000-4-3 (Radiation Immunity): 10V/m, Perf. Criteria A
	IEC61000-4-4 (EFT): ±1KV, Perf. Criteria B (with recommended circuit)
	IEC61000-4-5 Line to line: ±1KV, Perf. Criteria B (with recommended circuit)
	IEC61000-4-6 (Conducted Disturbance Immunity): 3Vr.m.s, Perf. Criteria A

Derating

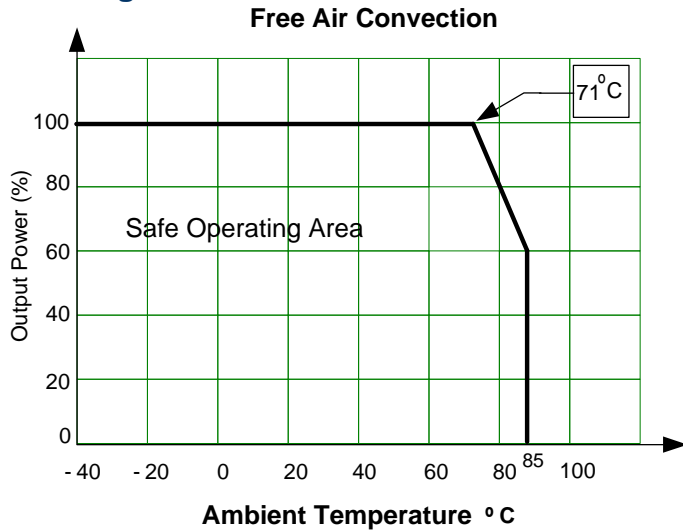

Standard Application circuit – positive output

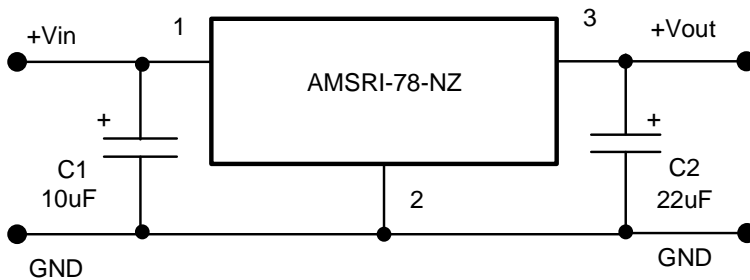

Dimensions

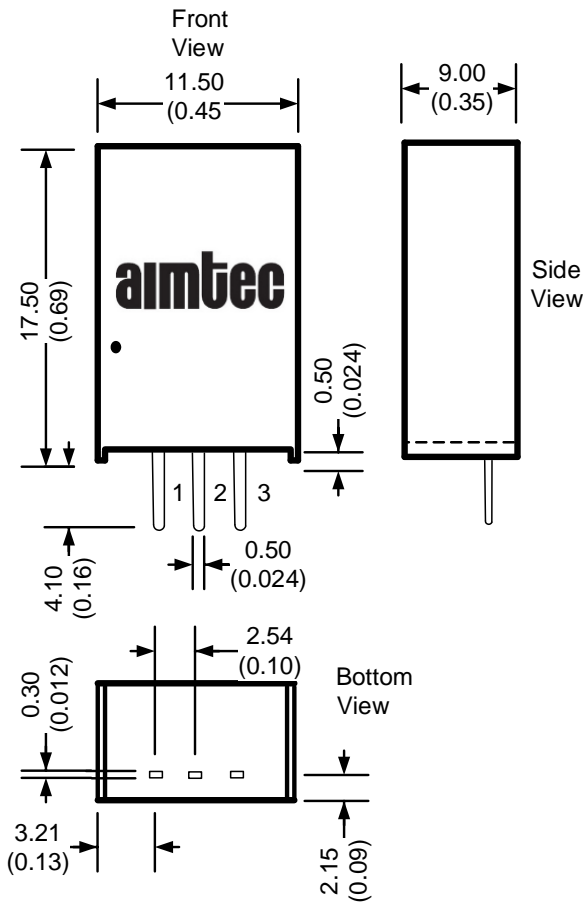

Footprint

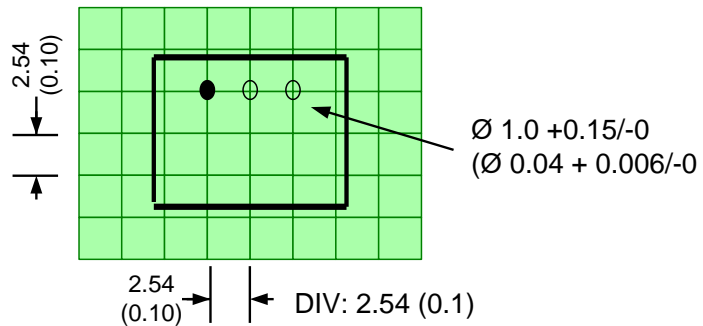

Dimensions are typical values: mm (inch)
 General Tolerance: ± 0.25 (± 0.01)
 Pin Tolerance: ± 0.1 (± 0.004)

L Models

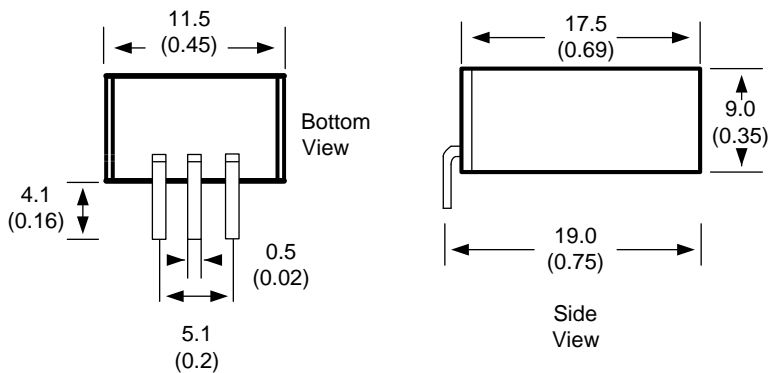

Footprint

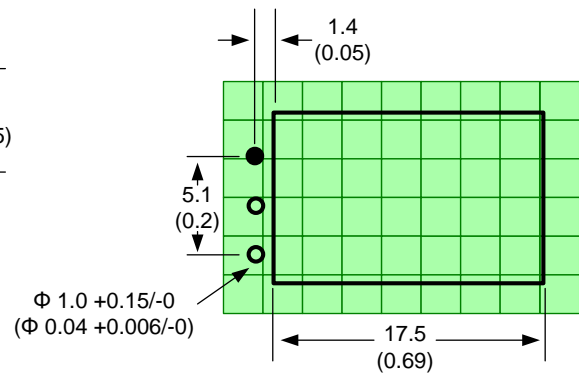

Pin Out Specifications

Pin	Positive	Negative
1	+V Input	+V Input
2	Ground	-V Output
3	+V Output	Ground

Standard Application circuit – negative output

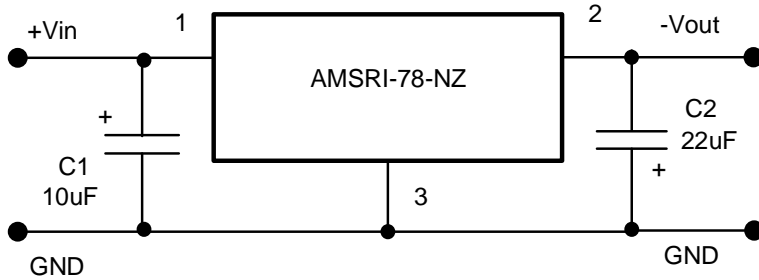

Ripple and Noise Reduction

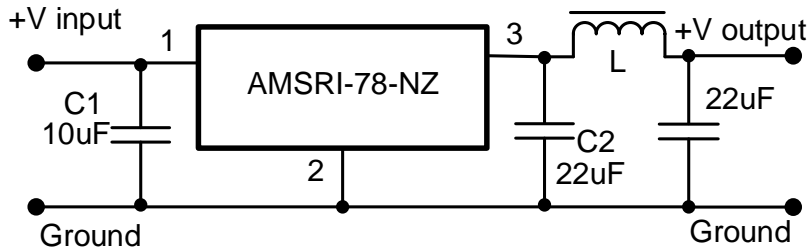

Recommended value of inductor L is between 10uH to 47uH

NOTE: This part is not designed for parallel operation, only input parallel supply to achieve positive and negative output

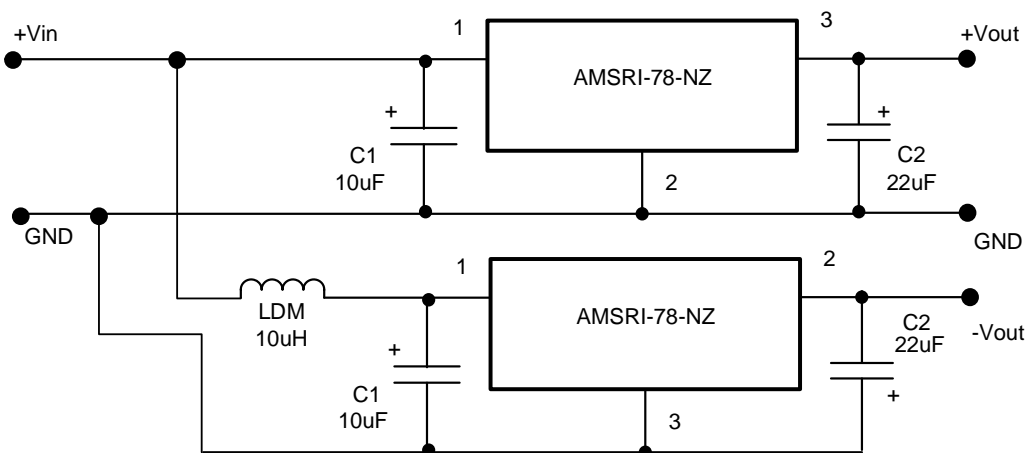

Recommended EMC circuit

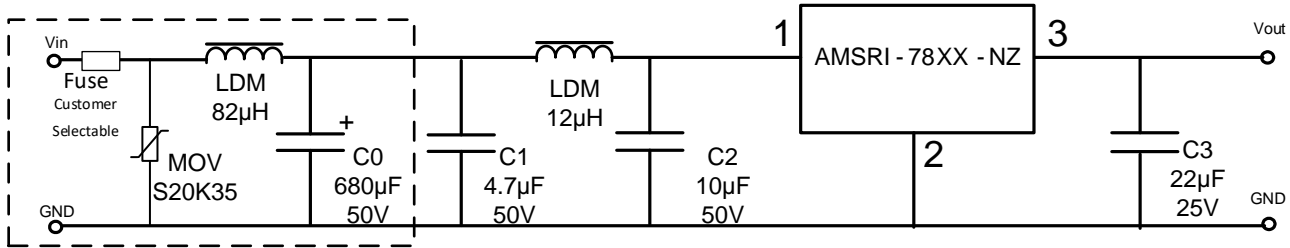

NOTE: **1.** Datasheets are updated as needed and as such, specifications are subject to change without notice. Once printed or downloaded, datasheets are no longer controlled by Aimtec; refer to www.aimtec.com for the most current product specifications. **2.** Product labels shown, including safety agency certifications on labels, may vary based on the date manufactured. **3.** Mechanical drawings and specifications are for reference only. **4.** All specifications are measured at an ambient temperature of 25°C, humidity<75%, nominal input voltage and at rated output load unless otherwise specified. **5.** Aimtec may not have conducted destructive testing or chemical analysis on all internal components and chemicals at the time of publishing this document. CAS numbers and other limited information are considered proprietary and may not be available for release. **6.** This product is not designed for use in critical life support systems, equipment used in hazardous environments, nuclear control systems or other such applications which necessitate specific safety and regulatory standards other the ones listed in this datasheet. **7.** Warranty is in accordance with Aimtec's standard Terms of Sale available at www.aimtec.com.