



FEATURES:

- Connectors on input/output
- Operating temperature: -40°C to +85°C
- Over load, Over voltage, Short circuit protection
- Universal Input: 90-260VAC, 47-440Hz, or 120-370VDC
- Energy star compliant
- 4000VAC I/O isolation
- Low ripple and noise
- CE, cULus, CB approvals



Models
Single output

Model	Input Voltage (VAC/Hz)	Input Voltage (VDC)	Output Voltage (V)	Output Current max (A)	Efficiency (%)
AMEC40-3.3SMAZ	90-264/47-440	120-370	3.3	8	78
AMEC40-5SMAZ	90-264/47-440	120-370	5	8	82
AMEC40-12SMAZ	90-264/47-440	120-370	12	3.33	84
AMEC40-15SMAZ	90-264/47-440	120-370	15	2.66	83
AMEC40-24SMAZ	90-264/47-440	120-370	24	1.66	82

Models
Dual output

Model	Input Voltage (VAC/Hz)	Input Voltage (VDC)	Output Voltage (V)	Output Current max (A)	Efficiency (%)
AMEC40-5DMAZ	90-264/47-440	120-370	±5	±4	80
AMEC40-12DMAZ	90-264/47-440	120-370	±12	±1.66	85
AMEC40-15DMAZ	90-264/47-440	120-370	±15	±1.33	82
AMEC40-24DMAZ	90-260/47-440	120-370	±24	±0.835	77

NOTE: All specifications in this datasheet are measured at an ambient temperature of 25°C, humidity<75%, nominal input voltage and at rated output load unless otherwise specified.

Input Specifications

Parameters	Conditions	Typical	Maximum	Units
Current	115 VAC		1000	mA
	230 VAC		530	
Inrush current <2ms	115 VAC		25	A
	230 VAC		50	
Leakage current			150	µA
External fuse	Recommended slow blow type	3.15		A
Input dissipation	No load; 115VAC	<0.5		W
	No load; 264VAC	<0.8		
Start-up time		117		ms

Output Specifications

Parameters	Conditions	Typical	Maximum	Units
Voltage accuracy		±2		%
Line regulation	(LL-HL)	±0.5		%
Load regulation	0-100% load single	±1		%
	0-100% load dual	±2		
Cross regulation	25% load - 1 st out, 100% load - 2 nd out	±5		%
Maximum Capacitive load	Depending of the model	470-23 000		µF
Transient response deviation	25% load Step	±2		% of Vout
Ripple & Noise*	20MHz bandwidth	50		mV p-p
Hold-up time (min)	115VAC	29		ms
Minimum Load Current		0		% of Max

*Ripple & Noise measured with 0.1µF M/C and 1µF E/C

Isolation Specifications

Parameters	Conditions	Typical	Rated	Units
Tested I/O voltage	3 sec		4000	VAC
Isolation Resistance		>1000		MΩ

General Specifications

Parameters	Conditions	Typical	Maximum	Units
Switching frequency		47		KHz
Over current protection	Auto recovery	110	140	%
Over voltage protection		Zener diode clamp	110	%
Short circuit protection		Hiccup mode, indefinite		
Short Circuit restart		Auto recovery		
Operating temperature	With derating above 50°C	-40 - +85		°C
Maximum case temperature			100	°C
Storage temperature		-40 to +95		°C
Temperature coefficient		0.02		% / °C
Cooling		Free air convection		
Humidity	Non condensing		95	% RH
Case material		Metal		
Weight		270		g
Dimensions (L x H x W)		4.92 x 2.56 x 1.38 inches / 125.00 x 65.00 x 35.00 mm		
MTBF		> 800 000 hrs (MIL-HDBK -217F, t=+25°C)		

Environment Approval

Test	Parameters	Conditions
Shock	Wave form	Half sine wave
	Acceleration amplitude	5gn
	Bump duration	30 ms
	Converter operation	Before and after test, body mounted (on chassis)
	Number of bumps	18 (3 in each direction for every axis)
Vibration	Test mode	Sweep sine, 10-100Hz, speed 0.05Hz/s
	Displacement	1 mm
	Acceleration	3g, 3 loops 30min one cycle, 3h total, every axis tested
	Converter operation	Before and after test, body mounted (on chassis)

Safety Specifications

Parameters		
Agency approvals	cULus, CE, CB Scheme	
Standards	Medical Electrical Equipment	IEC/EN/UL 60601-1, CSA-C22.2 No. 601.1-M90
	Information technology Equipment	EN 60950-1:2006+A11:2009
	EMI - Conducted and radiated emission	EN55011, class B
	Harmonic Current Emissions	IEC/EN 61000-3-2, (EN60555-2)
	Voltage fluctuations and flicker	IEC/EN 61000-3-3, (EN60555-3)
	Electrostatic Discharge Immunity	IEC 61000-4-2
	RF, Electromagnetic Field Immunity	IEC 61000-4-3
	Electrical Fast Transient/Burst Immunity	IEC 61000-4-4
	Surge Immunity	IEC 61000-4-5
	RF, Conducted Disturbance Immunity	IEC 61000-4-6
	Power frequency Magnetic Field Immunity	IEC 61000-4-8
Voltage dips, Short Interruptions Immunity	IEC 61000-4-11	

Pin Out Specifications

Pin	Single	Dual
1	AC Input (L)	AC Input (L)
2	AC Input (N)	AC Input (N)
3	+V Output	+V Output
4	-V Output	Common
5	N.C.	Common
6	N.C.	-V Output

N.C.: Not Connected

Dimensions

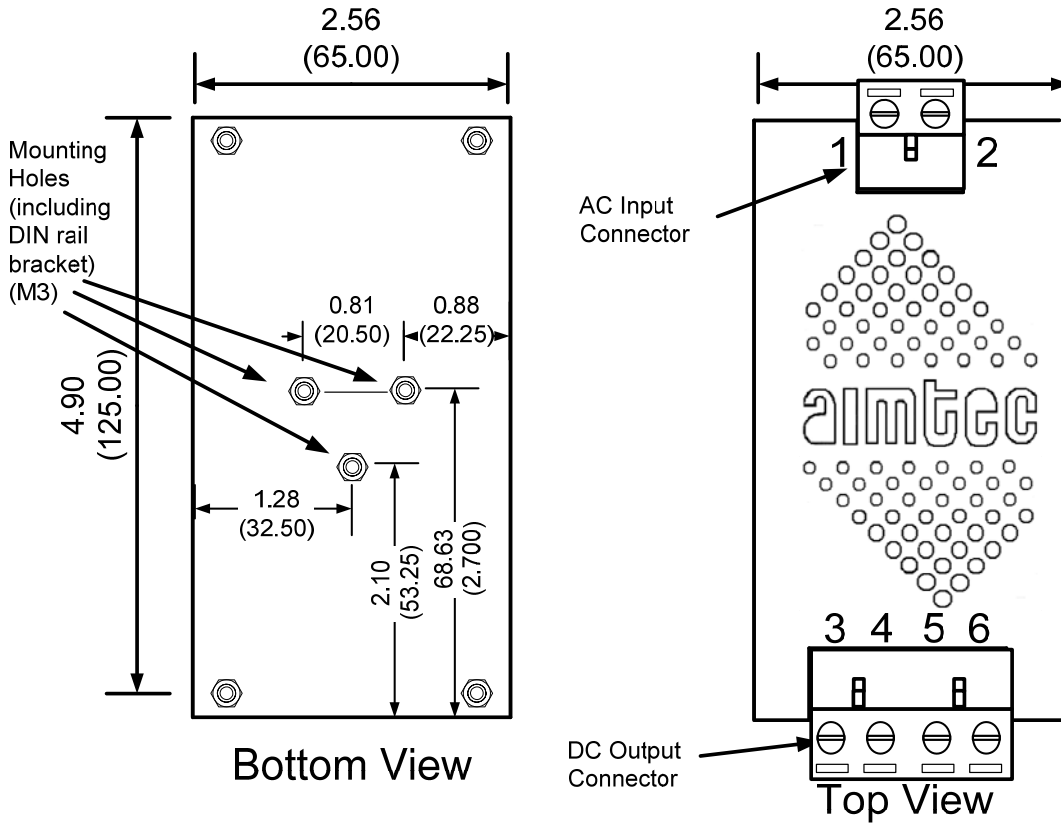

Dimensions: inch (mm)
Case Tolerance: ± 0.05 (± 1.30)

Side View

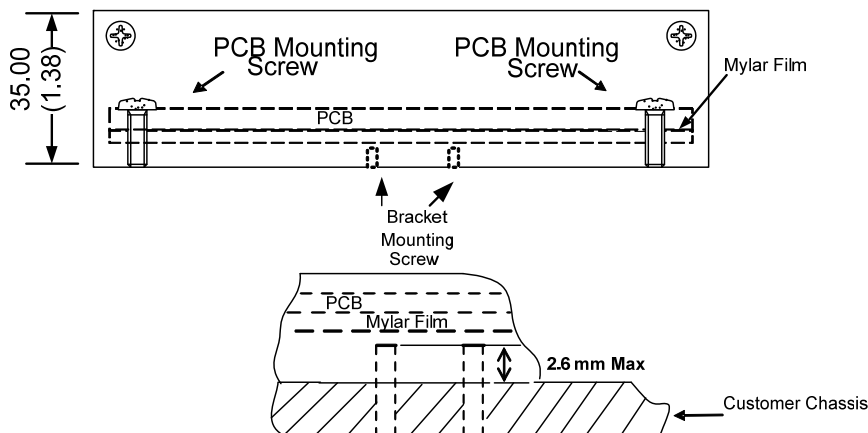

Optional DIN Rail Bracket

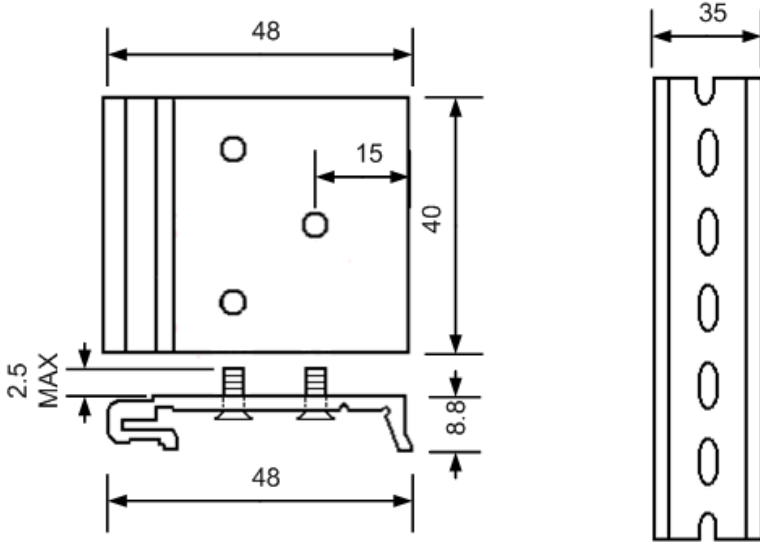

To order optional DIN rail bracket kit specify part number DRB01 when placing order

Optional DIN Rail Bracket compatible with DIN Rail TS35/7.5

Derating

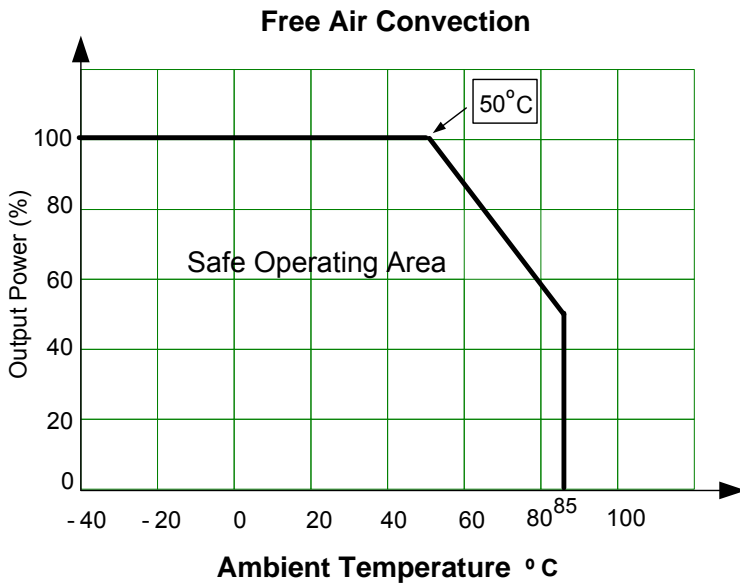

NOTE: 1. Datasheets are updated as needed and as such, specifications are subject to change without notice. Once printed or downloaded, datasheets are no longer controlled by Aimtec; refer to www.aimtec.com for the most current product specifications. 2. Product labels shown, including safety agency certifications on labels, may vary based on the date manufactured. 3. Mechanical drawings and specifications are for reference only. 4. All specifications are measured at an ambient temperature of 25°C, humidity<75%, nominal input voltage and at rated output load unless otherwise specified. 5. Aimtec may not have conducted destructive testing or chemical analysis on all internal components and chemicals at the time of publishing this document. CAS numbers and other limited information are considered proprietary and may not be available for release. 6. This product is not designed for use in critical life support systems, equipment used in hazardous environments, nuclear control systems or other such applications which necessitate specific safety and regulatory standards other the ones listed in this datasheet. 7. Warranty is in accordance with Aimtec's standard Terms of Sale available at www.aimtec.com.