



**FEATURES:**

- High Power LED Driver
- Wide (7:1) Input Voltage Range
- Remote Control Function
- 24 Pin DIP Package
- Constant Output Current
- High Efficiency (Up to 96%)
- Dimming Function (0 – 100%)
- Operating Temperature range -40°C - +85°C

**Models**  
**Single output**



Model	Input Voltage (V)	Output Voltage (V)	Output Current (mA)	Efficiency Max (%)
AMLD-3630IZ	5-36	2-32	300	96
AMLD-3635IZ	5-36	2-32	350	96
AMLD-3650IZ	5-36	2-32	500	96
AMLD-3660IZ	5-36	2-32	600	96
AMLD-3670IZ	5-36	2-32	700	96
AMLD-3680IZ	5-36	2-32	800	96
AMLD-3690IZ	5-36	2-32	900	96
AMLD-36100IZ	5-36	2-32	1000	96
AMLD-36110IZ	5-36	2-32	1100	96
AMLD-36120IZ	5-36	2-32	1200	96

NOTE: All specifications in this datasheet are measured at an ambient temperature of 25°C, humidity<75%, nominal input voltage and at rated output load unless otherwise specified.

**Input Specifications**

Parameters	Nominal	Typical	Maximum	Units
Voltage range	24	5-36	36	VDC
On/Off Control (Analog Control)	ON: Open or 0V > V < 0.6V			
Input voltage range (0-12Vdc) (Leave open if not used)	OFF: 0.6V > V < 5V (1mA Max)			
Dimming Control (Digital Control)	Max PWM Frequency (10%~90%) 200Hz			
Dimming Control (Analog Control)	0-4.5V (1mA max) Analog Voltage (0%~100%) models: AMLD-3630IZ, AMLD-3635IZ, AMLD-3650IZ			
Input voltage range (0-12Vdc)* (Leave open if not used)	0-6.5V (1mA max) Analog Voltage (0%~100%) models: AMLD-3660IZ, AMLD-3670IZ, AMLD-3680IZ, AMLD-3690IZ, AMLD-36100IZ, AMLD-36110IZ, AMLD-36120IZ			

\* NOTE: Exceeding 12Vdc on Dimming Control pin will damage the converter.

**Output Specifications**

Parameters	Conditions	Typical	Maximum	Units
Current accuracy		±2		%
Short Circuit protection	Regulated at the rated current for each model			
Output Open Protection	No Load			
Max load capacitance			100	µF
Ripple & Noise	20MHz Bandwidth	120		mV p-p

**General Specifications**

Parameters	Conditions	Typical	Maximum	Units
Switching frequency	100% load	260		KHz
Operating temperature		-40 to +85		°C
Storage temperature		-40 to +125		°C
Max Case temperature			100	°C
Cooling	Free Air Convection			
Thermal Impedance		13.17		°C/W
Humidity			95	% RH
Case material	Non-Conductive Black Plastic			



**Application Circuit**

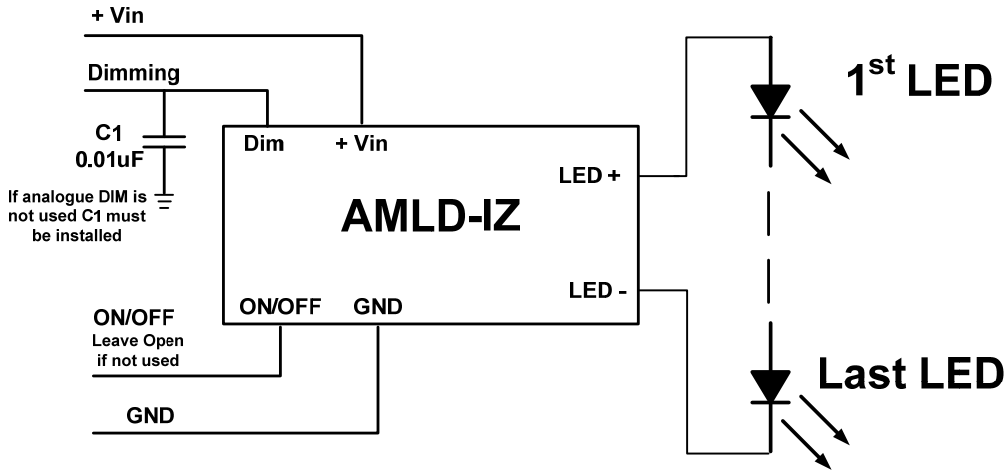

**Note:** The relation between input and output voltage for AMLD-IZ LED Driver step-down converter series is:  
 $V_{in} - 4V \geq V_{out} \geq \text{Total LED voltage}$   
 $V_{out} / \text{LED voltage} = \text{LED quantity}$

**Output Current Versus Dimming Voltage**

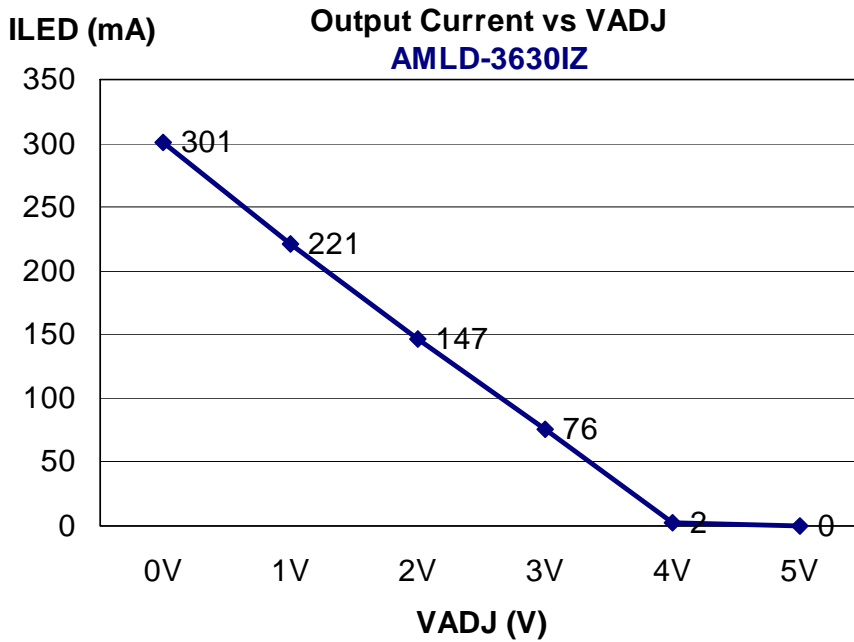

**Output Current vs Dimming Voltage (continued)**

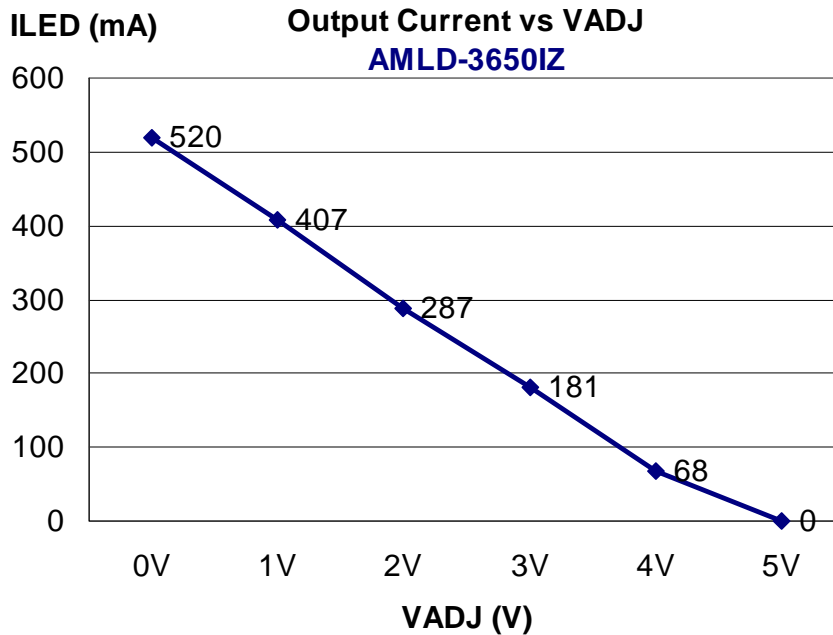
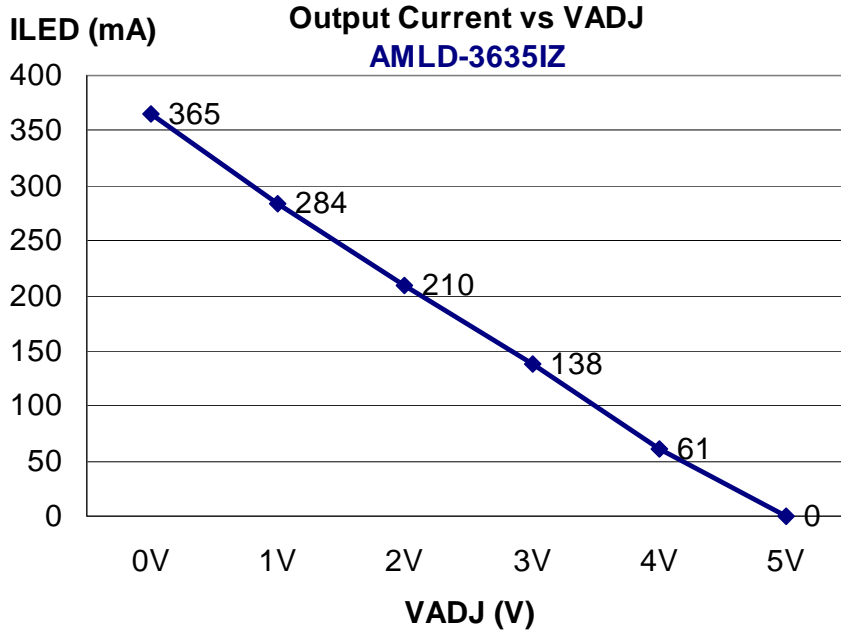

**Output Current vs Dimming Voltage (continued)**

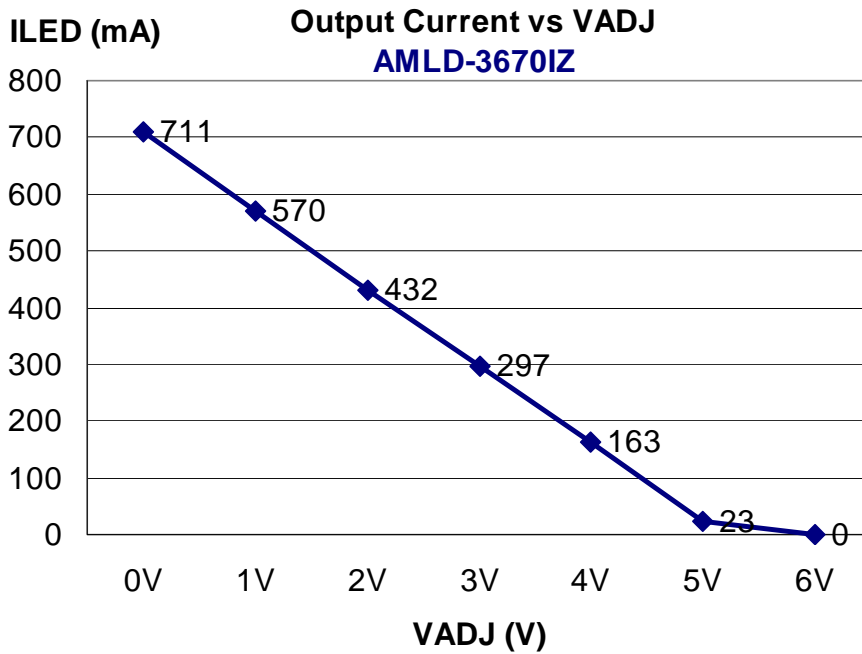
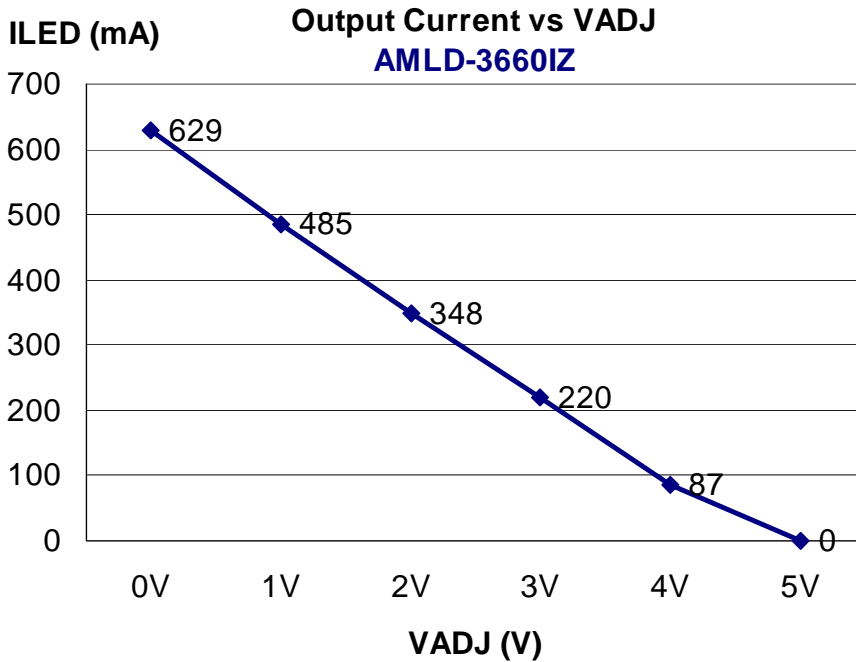

**Output Current vs Dimming Voltage (continued)**

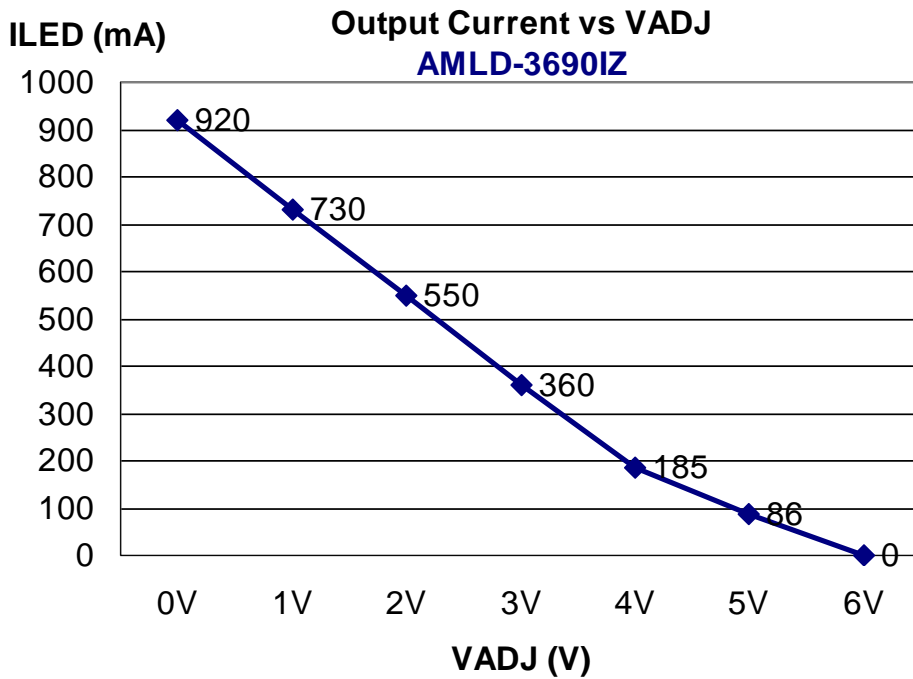
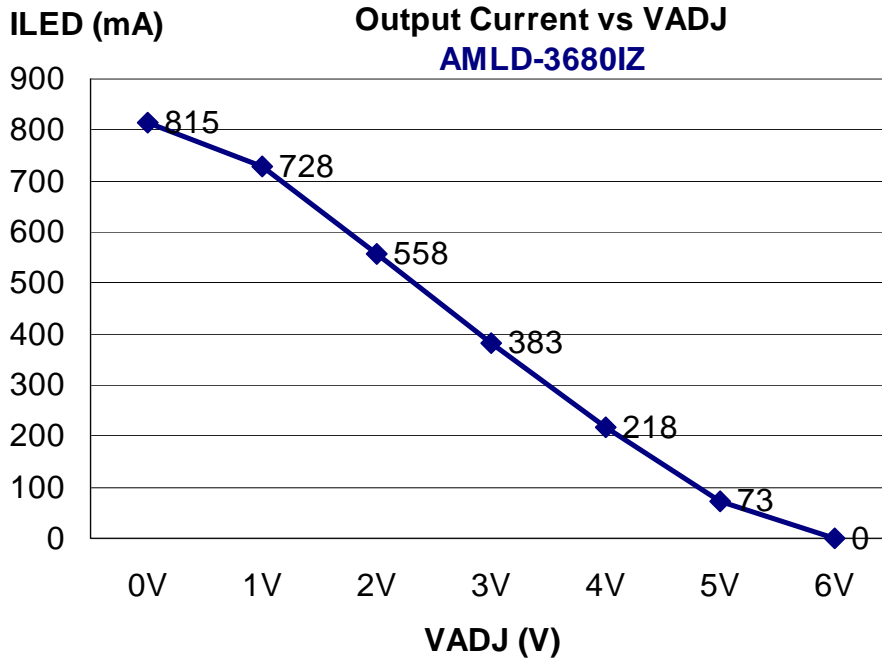

**Output Current vs Dimming Voltage (continued)**

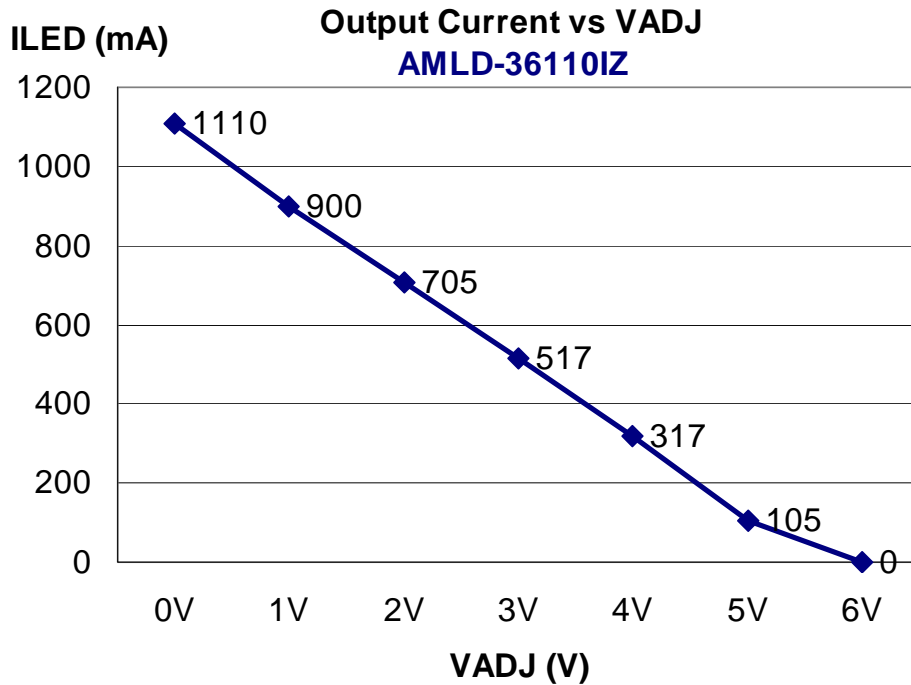
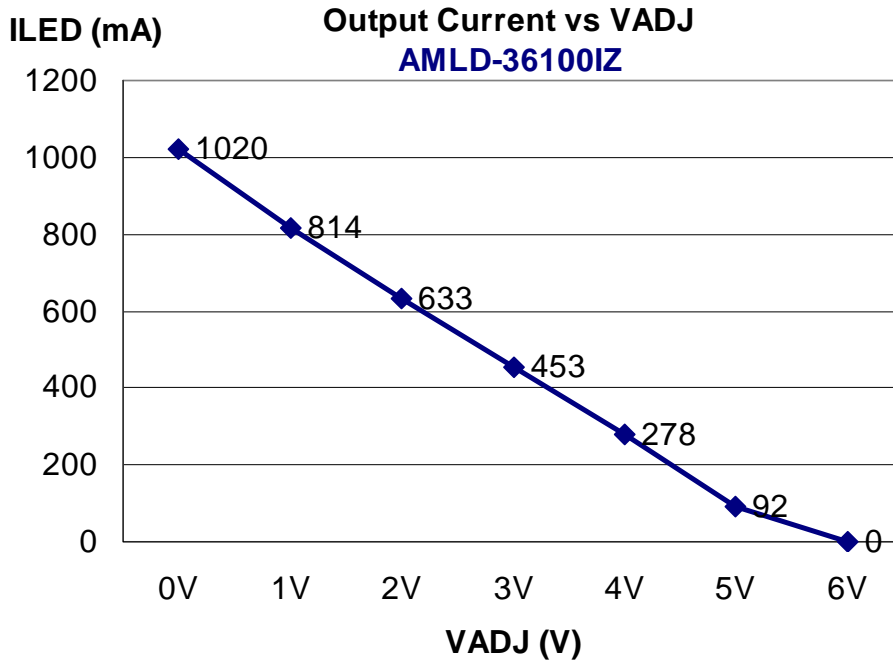

**Output Current vs Dimming Voltage (continued)**

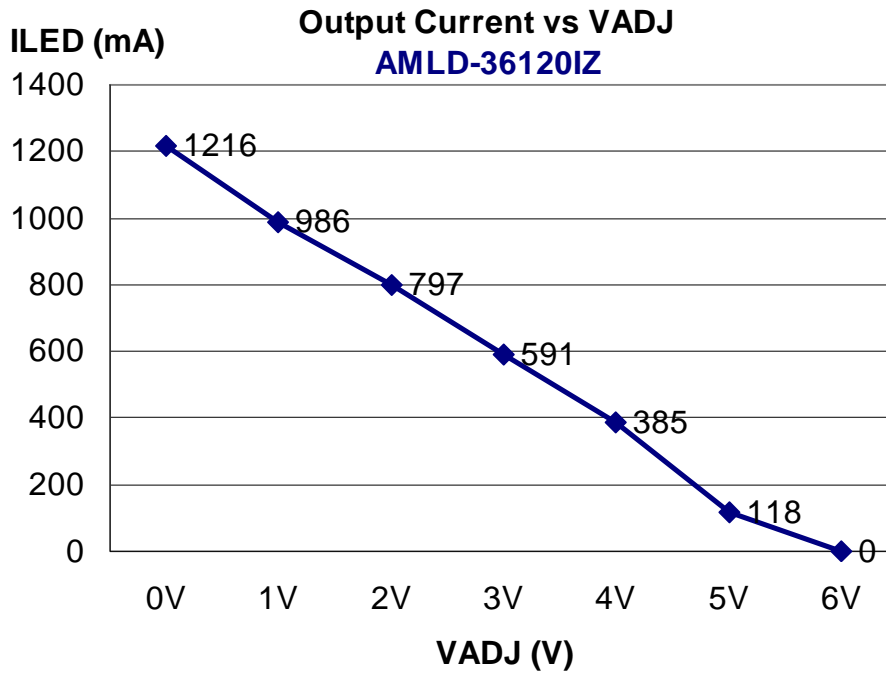

**NOTE:** 1. Datasheets are updated as needed and as such, specifications are subject to change without notice. Once printed or downloaded, datasheets are no longer controlled by Aimtec; refer to [www.aimtec.com](http://www.aimtec.com) for the most current product specifications. 2. Product labels shown, including safety agency certifications on labels, may vary based on the date manufactured. 3. Mechanical drawings and specifications are for reference only. 4. All specifications are measured at an ambient temperature of 25°C, humidity<75%, nominal input voltage and at rated output load unless otherwise specified. 5. Aimtec may not have conducted destructive testing or chemical analysis on all internal components and chemicals at the time of publishing this document. CAS numbers and other limited information are considered proprietary and may not be available for release. 5. This product is not designed for use in critical life support systems, equipment used in hazardous environments, nuclear control systems or other such applications which necessitate specific safety and regulatory standards other the ones listed in this datasheet.